



MODEL NAME :	690C
TECHNOLOGY:	ENHANCED FLOODED BATTERY (EFB)

ELECTRICAL			
RESERVE CAPACITY	IEC*/EN	NOMINAL CAPACITY	SAE
220	825	132	825

DIMENSIONS			
Length	Width	Height	O/A Height
514	220	206	206

BATTERY DIAGRAM

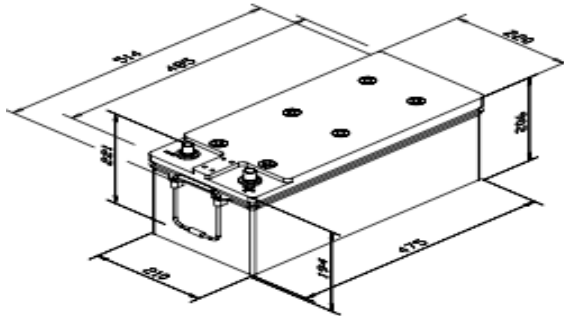

TERMINAL TYPE

TERMINAL LAYOUT

