

Industrial Batteries – Standby Power
Sonnenschein A400
Outstanding cost efficient.

Specifications

Make use of the superiority of the experienced dryfit technology.

Specifications

- The success of Sonnenschein A400 batteries comes from the internationally superior dryfit technology
- Exceptional energy storage capacity combined with long life
- Maintenance-free (no topping up) during the whole service life due to the Sonnenschein dryfit technology
- Nominal capacity 5.5 – 180 Ah C₁₀
- 12 years design life at 20°C ambient temperature (80% remaining capacity from C₁₀)
- Grid plate construction consisting of a lead calcium alloy
- Very low gassing due to internal gas recombination
- Shelf life up to 2 years at 20°C without recharge due to the very low self discharge rate
- Short recharging time
- Proof against deep discharge according to DIN 43 539 T5
- Trouble-free transportation of operational blocks, no restrictions for rail, road, sea and air transportation (IATA, DGR clause A 67)
- Completely recyclable



Applications

In telecommunications, Sonnenschein A400 batteries are simply indispensable. But also in applications like utility, emergency lighting, security, railways and other safety power supplies the Sonnenschein A400 is an absolutely reliable source of energy.



Valve regulated lead acid batteries



Grid plate



Nominal capacity 5.5 – 180 Ah



Block battery



Design life: 12 years



Maintenance-free (no topping up)



Proof against deep discharge acc. to DIN 43 539 T5



Recyclable

Type	Part number	Nominal voltage	Nominal capacity	Discharge current	Max. load*	Length (l)	Width (b/w)	Height up to top of cover (h1)	Height over terminals (h2)	Weight	Internal resistance acc. to IEC 896-2	Short circuit current acc. to IEC 896-2	Terminal
		V	C ₁₀ 1.8 V/C 20°C Ah	I ₁₀ A	approx. A	max. mm	max. mm	max. mm	max. mm	approx. kg	m Ω	A	
A406/165 A	NGA4060165HSOCA	6	165.0	16.50	770	190	244.0	254.0	275.0	31.0	2.1	2800	A-Terminal
A406/165 F10	NGA4060165HSOFA	6	165.0	16.50	770	190	244.0	254.0	282.0***	31.5	2.1	2800	F-M10
A412/5.5 SR	NGA41205D5HSORA	12	5.5	0.55	80	152	65.5	94.5	98.4	2.5	138.0	93	SR-6.3
A412/8.5 SR	NGA41208D5HSORA	12	8.5	0.85	80	152	98.0	94.5	98.4	3.6	86.0	150	SR-6.3
A412/12 SR	NGA4120012HSORA	12	12.0	1.20	100	181	76.0	152.0	156.4	5.5	47.0	260	SR-6.3
A412/20 G5	NGA4120020HSOBA	12	20.0	2.00	200	167	176.0	126.0	126.0	8.5	25.0	460	G-M5
A412/32 G6	NGA4120032HSOBA	12	32.0	3.20	400	210	175.0	175.0	175.0	13.6	15.0	784	G-M6
A412/32 F10	NGA4120032HSOFA	12	32.0	3.20	400	210	175.0	175.0	181.0***	14.1	15.0	784	F-M10
A412/50 A	NGA4120050HSOCA	12	50.0	5.00	440	278	175.0	190.0	190.0	19.5	10.0	1220	A-Terminal
A412/50 F10	NGA4120050HSOFA	12	50.0	5.00	440	278	175.0	190.0	196.0***	20.0	10.0	1220	F-M10
A412/50 G6	NGA4120050HSOBA	12	50.0	5.00	440	278	175.0	190.0	190.0	19.5	10.0	1220	G-M6
A412/65 F10	NGA4120065HSOFA	12	65.0	6.50	440	353	175.0	190.0	196.0***	25.1	9.0	1414	F-M10
A412/65 G6	NGA4120065HSOBA	12	65.0	6.50	440	353	175.0	190.0	190.0	24.6	9.0	1414	G-M6
A412/85 F10**	NGA4120085HSOFA	12	85.0	8.50	770	204	244.0	250.0	276.0***	32.0	8.0	1472	F-M10
A412/90 A	NGA4120090HSOCA	12	90.0	9.00	770	286	269.0	208.0	230.0	34.5	7.0	1733	A-Terminal
A412/90 F10	NGA4120090HSOFA	12	90.0	9.00	770	286	269.0	208.0	237.0***	35.0	7.0	1733	F-M10
A412/100 A	NGA4120100HSOCA	12	100.0	10.00	770	513	189.0	195.0	223.0	39.0	6.9	1777	A-Terminal
A412/100 F10	NGA4120100HSOFA	12	100.0	10.00	770	513	189.0	195.0	223.0***	39.5	6.9	1777	F-M10
A412/120 A	NGA4120120HSOCA	12	120.0	12.00	770	513	223.0	195.0	223.0	48.0	5.7	2118	A-Terminal
A412/120 F10	NGA4120120HSOFA	12	120.0	12.00	770	513	223.0	195.0	223.0***	49.5	5.7	2118	F-M10
A412/180 A	NGA4120180HSOCA	12	180.0	18.00	770	518	274.0	216.0	238.0	69.5	3.8	3227	A-Terminal
A412/180 F10	NGA4120180HSOFA	12	180.0	18.00	770	518	274.0	216.0	244.0***	70.0	3.8	3227	F-M10

*With suitable matching contacts **With central degassing ***plus max. 24 mm for connector/screw

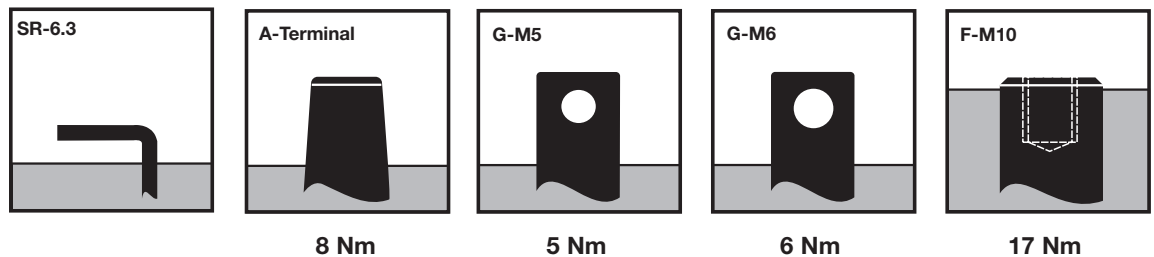
Container, approval, terminal and torque

Container: 5.5–12 Ah = ABS
20–180 Ah = Polypropylene (PP)

Approval: Underwriters Laboratories (UL), USA
DIN/Gost/TÜV, Russia

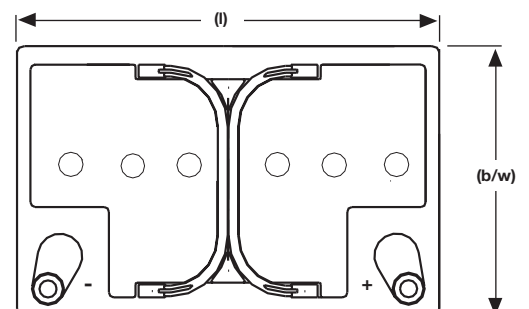
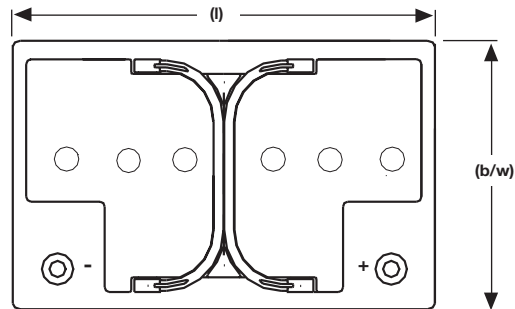
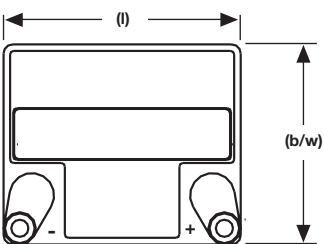
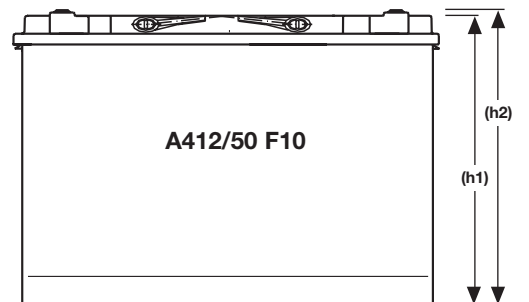
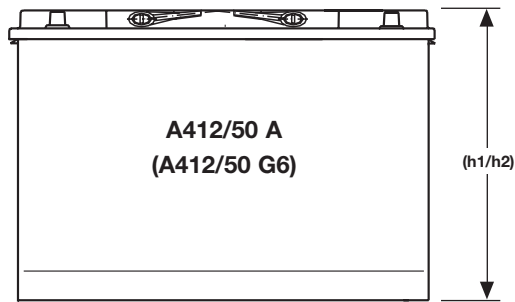
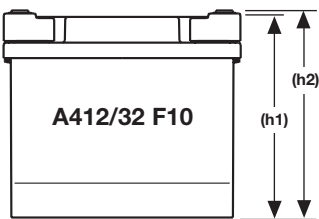
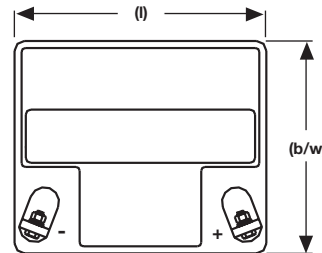
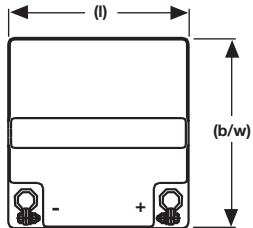
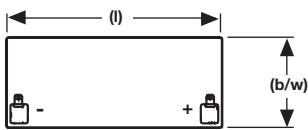
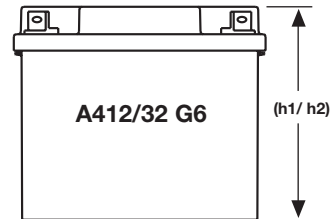
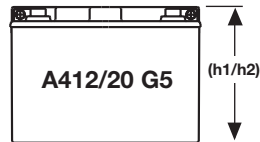
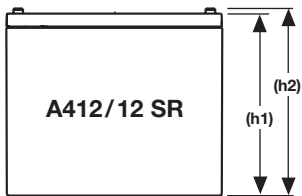
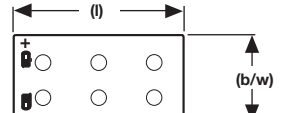
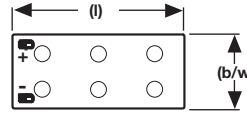
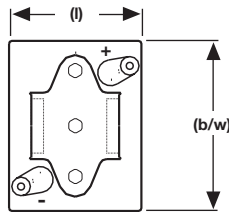
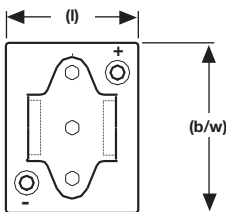
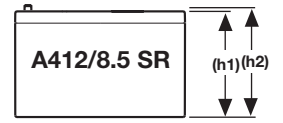
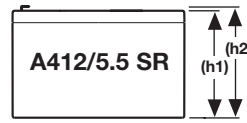
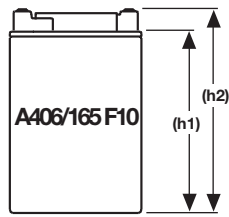
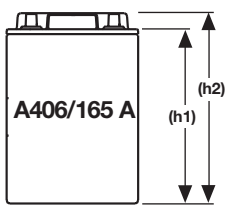

Not to scale!

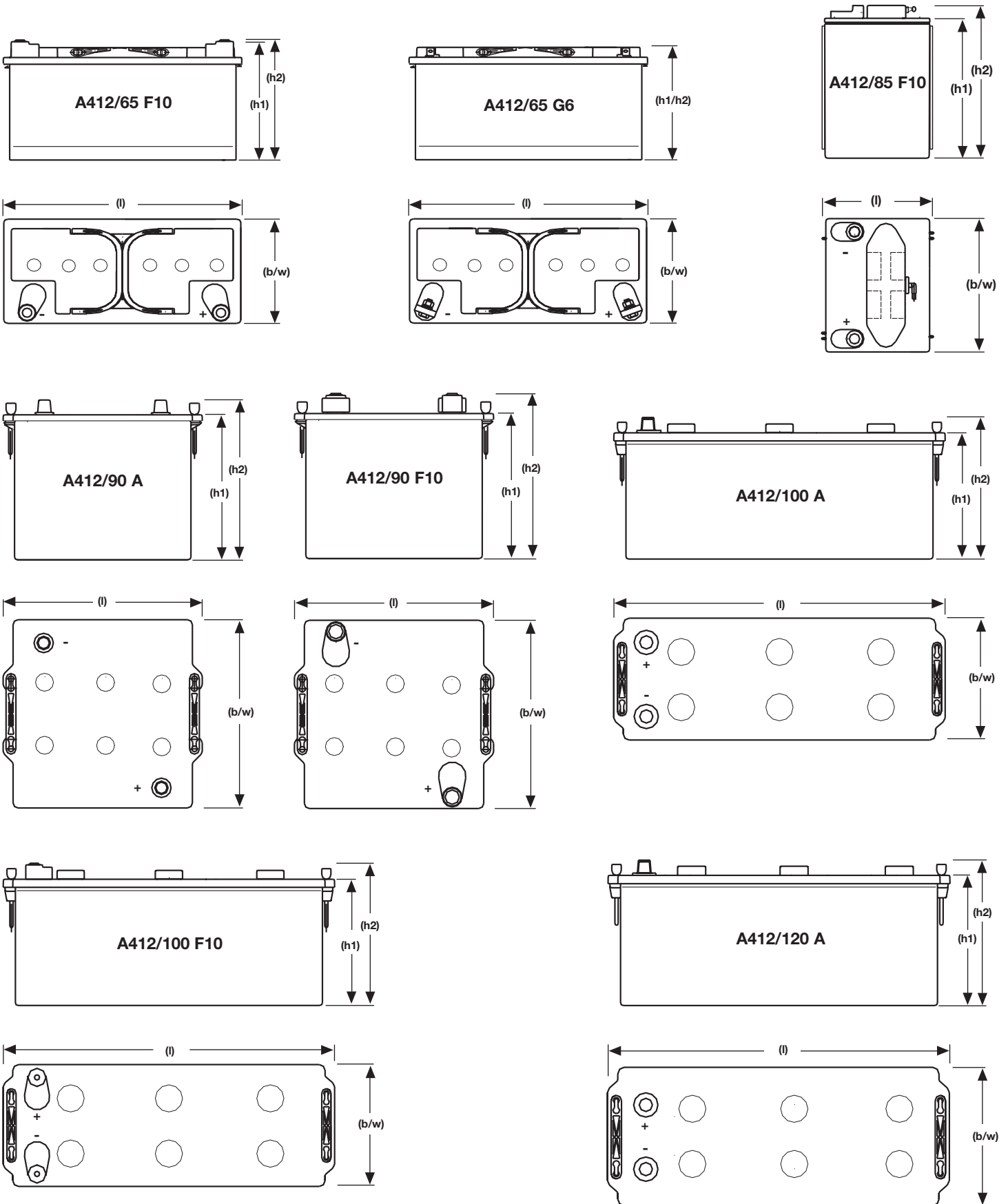

Not to scale!

Dimensions

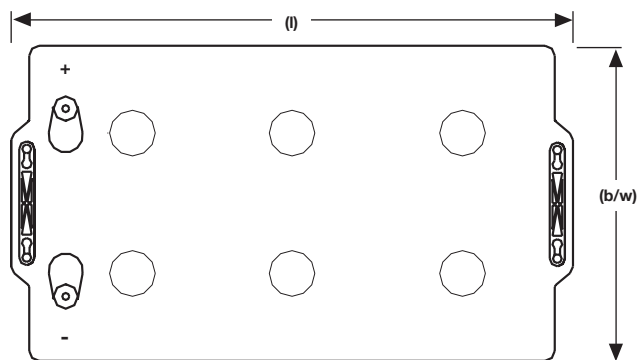
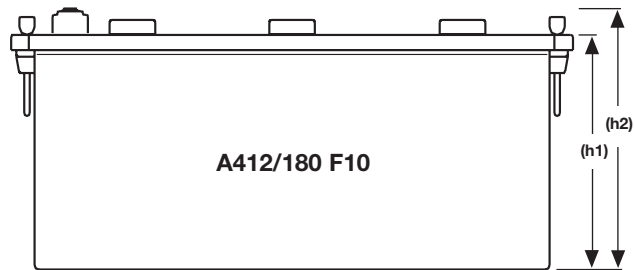
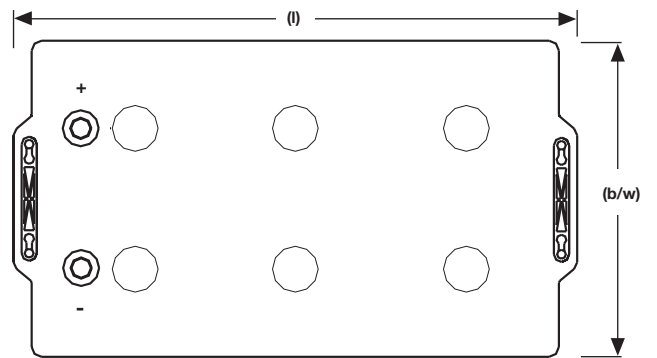
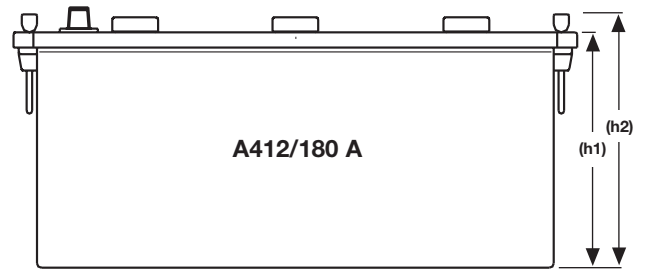
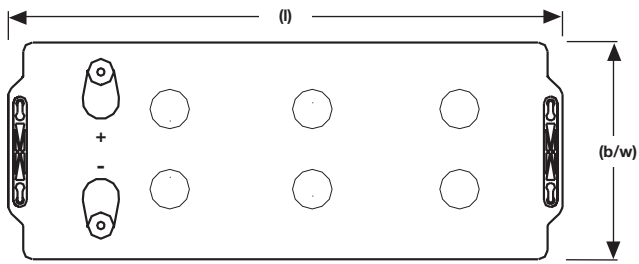
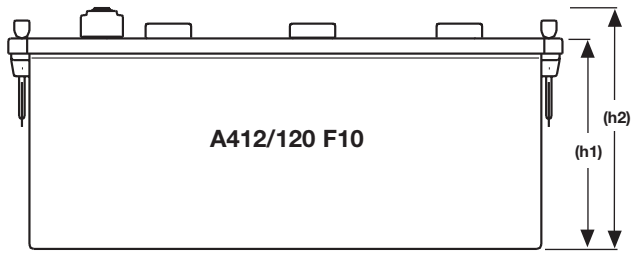

Not to scale!

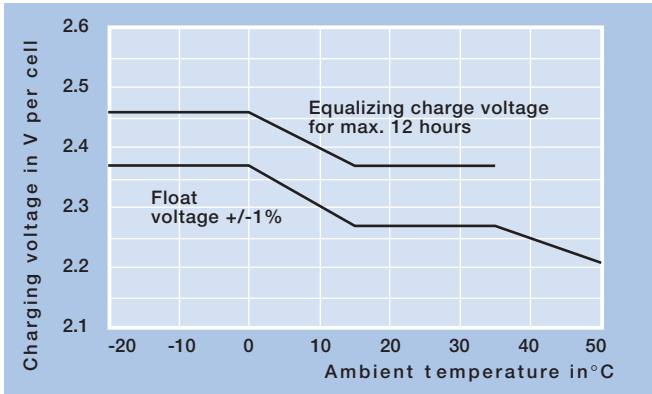

For charging 2.27 V/cell is recommended. The charging voltage must be compensated according to the curve for continuously different battery ambient temperature.

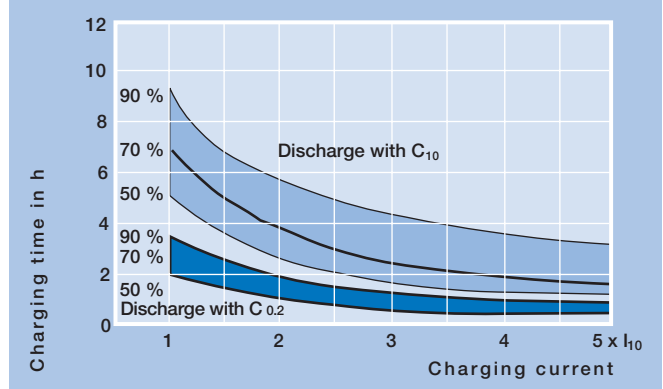

Recharging time in dependence of charging current (guide values) for up to 50, 70 and 90% of capacity at 20°C and with a charging voltage of 2.27 V/cell.

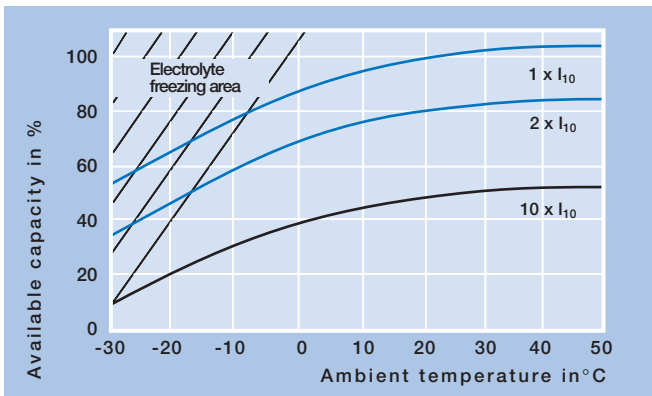

Extracted capacity in relation to the temperature.

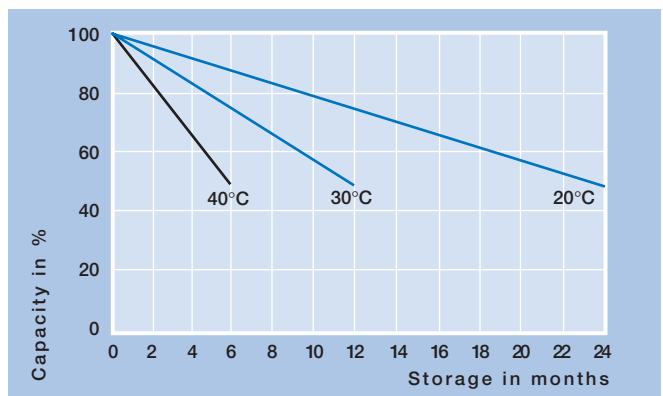

Self-discharge in relation to the storage temperature.

1.85 V/C – Discharge in A at 20°C

Typ	Sachnummer	5min	10min	15min	20min	30min	45min	1h	2h	3h	4h	5h	8h	10h
A406/165A	NGA4060165HSOCA	196.0	163.0	143.0	131.0	115.0	98.0	82.0	53.0	41.0	32.4	27.0	18.1	15.9
A406/165F10	NGA4060165HSOFA	196.0	163.0	143.0	131.0	115.0	98.0	82.0	53.0	41.0	32.4	27.0	18.1	15.9
A412/5.5SR	NGA41205D5HSORA	9.9	8.3	7.0	6.0	4.9	3.8	3.0	2.0	1.4	1.1	1.0	0.6	0.5
A412/8.5SR	NGA41208D5HSORA	15.0	12.0	10.0	8.0	6.9	5.3	4.3	2.8	2.1	1.7	1.4	1.0	0.8
A412/12SR	NGA4120012HSORA	18.0	15.0	12.0	11.0	9.0	7.0	5.5	3.3	2.5	2.0	1.7	1.2	1.1
A412/20G5	NGA4120020HSOBA	33.0	25.0	22.0	20.0	17.0	14.0	11.0	6.0	4.7	3.8	3.2	2.1	1.9
A412/32G6	NGA4120032HSOBA	53.0	43.0	36.0	32.0	28.0	21.0	17.0	11.0	8.1	6.5	5.4	3.7	3.0
A412/32F10	NGA4120032HSOFA	53.0	43.0	36.0	32.0	28.0	21.0	17.0	11.0	8.1	6.5	5.4	3.7	3.0
A412/50A	NGA4120050HSOCA	81.0	68.0	57.0	51.0	42.0	34.0	28.0	18.0	12.8	10.2	8.5	5.7	4.8
A412/50F10	NGA4120050HSOFA	81.0	68.0	57.0	51.0	42.0	34.0	28.0	18.0	12.8	10.2	8.5	5.7	4.8
A412/50G6	NGA4120050HSOBA	81.0	68.0	57.0	51.0	42.0	34.0	28.0	18.0	12.8	10.2	8.5	5.7	4.8
A412/65F10	NGA4120065HSOFA	102.0	77.0	63.0	56.0	48.0	42.0	36.0	22.0	15.9	12.9	10.9	7.3	6.2
A412/65G6	NGA4120065HSOBA	102.0	77.0	63.0	56.0	48.0	42.0	36.0	22.0	15.9	12.9	10.9	7.3	6.2
A412/85F10	NGA4120085HSOFA	121.0	103.0	89.0	80.0	71.0	55.0	45.0	29.0	21.3	16.9	14.1	9.6	8.2
A412/90A	NGA4120090HSOCA	136.0	117.0	100.0	89.0	71.0	55.0	46.0	30.0	22.8	17.6	14.8	10.4	8.9
A412/90F10	NGA4120090HSOFA	136.0	117.0	100.0	89.0	71.0	55.0	46.0	30.0	22.8	17.6	14.8	10.4	8.9
A412/100A	NGA4120100HSOCA	144.0	124.0	105.0	93.0	72.0	56.0	46.0	31.0	23.5	17.9	15.2	10.8	9.6
A412/100F10	NGA4120100HSOFA	144.0	124.0	105.0	93.0	72.0	56.0	46.0	31.0	23.5	17.9	15.2	10.8	9.6
A412/120A	NGA4120120HSOCA	175.0	138.0	120.0	108.0	95.0	78.0	61.0	37.0	27.5	22.3	18.9	13.0	11.3
A412/120F10	NGA4120120HSOFA	175.0	138.0	120.0	108.0	95.0	78.0	61.0	37.0	27.5	22.3	18.9	13.0	11.3
A412/180A	NGA4120180HSOCA	240.0	193.0	170.0	156.0	130.0	103.0	84.0	59.0	42.6	34.1	28.6	19.2	16.5
A412/180F10	NGA4120180HSOFA	240.0	193.0	170.0	156.0	130.0	103.0	84.0	59.0	42.6	34.1	28.6	19.2	16.5

1.80 V/C – Discharge in A at 20°C

Typ	Sachnummer	5min	10min	15min	20min	30min	45min	1h	2h	3h	4h	5h	8h	10h
A406/165A	NGA4060165HSOCA	243.0	211.0	180.0	158.0	132.0	109.0	88.0	56.0	43.1	33.9	28.2	18.8	16.5
A406/165F10	NGA4060165HSOFA	243.0	211.0	180.0	158.0	132.0	109.0	88.0	56.0	43.1	33.9	28.2	18.8	16.5
A412/5.5SR	NGA41205D5HSORA	11.3	9.3	7.8	6.5	5.1	4.0	3.2	2.1	1.5	1.2	1.0	0.7	0.5
A412/8.5SR	NGA41208D5HSORA	17.0	14.0	11.0	9.0	7.4	5.7	4.5	2.9	2.1	1.7	1.4	1.0	0.8
A412/12SR	NGA4120012HSORA	21.0	18.0	14.0	12.0	10.0	8.0	6.2	3.7	2.8	2.2	1.9	1.3	1.2
A412/20G5	NGA4120020HSOBA	36.0	27.0	23.0	21.0	18.0	15.0	12.0	7.0	4.9	3.9	3.3	2.2	2.0
A412/32G6	NGA4120032HSOBA	63.0	51.0	42.0	36.0	30.0	23.0	19.0	12.0	8.6	6.8	5.7	3.9	3.2
A412/32F10	NGA4120032HSOFA	63.0	51.0	42.0	36.0	30.0	23.0	19.0	12.0	8.6	6.8	5.7	3.9	3.2
A412/50A	NGA4120050HSOCA	98.0	81.0	66.0	57.0	46.0	37.0	29.0	19.0	13.3	10.5	8.8	5.9	5.0
A412/50F10	NGA4120050HSOFA	98.0	81.0	66.0	57.0	46.0	37.0	29.0	19.0	13.3	10.5	8.8	5.9	5.0
A412/50G6	NGA4120050HSOBA	98.0	81.0	66.0	57.0	46.0	37.0	29.0	19.0	13.3	10.5	8.8	5.9	5.0
A412/65F10	NGA4120065HSOFA	120.0	95.0	76.0	64.0	52.0	45.0	39.0	23.0	16.7	13.4	11.3	7.6	6.5
A412/65G6	NGA4120065HSOBA	120.0	95.0	76.0	64.0	52.0	45.0	39.0	23.0	16.7	13.4	11.3	7.6	6.5
A412/85F10	NGA4120085HSOFA	147.0	125.0	105.0	91.0	75.0	60.0	49.0	31.0	22.3	17.6	14.7	10.0	8.5
A412/90A	NGA4120090HSOCA	166.0	142.0	118.0	100.0	79.0	61.0	50.0	32.0	23.5	18.3	15.5	10.8	9.0
A412/90F10	NGA4120090HSOFA	166.0	142.0	118.0	100.0	79.0	61.0	50.0	32.0	23.5	18.3	15.5	10.8	9.0
A412/100A	NGA4120100HSOCA	176.0	150.0	125.0	104.0	81.0	62.0	50.0	32.0	24.1	18.7	15.9	11.3	10.0
A412/100F10	NGA4120100HSOFA	176.0	150.0	125.0	104.0	81.0	62.0	50.0	32.0	24.1	18.7	15.9	11.3	10.0
A412/120A	NGA4120120HSOCA	202.0	155.0	133.0	119.0	102.0	85.0	67.0	39.0	28.7	23.0	19.4	13.2	12.0
A412/120F10	NGA4120120HSOFA	202.0	155.0	133.0	119.0	102.0	85.0	67.0	39.0	28.7	23.0	19.4	13.2	12.0
A412/180A	NGA4120180HSOCA	291.0	235.0	195.0	171.0	144.0	112.0	90.0	62.0	44.7	35.5	29.7	19.9	18.0
A412/180F10	NGA4120180HSOFA	291.0	235.0	195.0	171.0	144.0	112.0	90.0	62.0	44.7	35.5	29.7	19.9	18.0

The values are measured at 20°C and may change depending on the application or ambient temperature.

1.75 V/C – Discharge in A at 20°C

Type	Part number	5min	10min	15min	20min	30min	45min	1h	2h	3h	4h	5h	8h	10h
A406/165A	NGA4060165HSOCA	290.0	246.0	210.0	180.0	143.0	115.0	92.0	58.0	43.7	34.4	28.6	19.1	16.6
A406/165F10	NGA4060165HSOFA	290.0	246.0	210.0	180.0	143.0	115.0	92.0	58.0	43.7	34.4	28.6	19.1	16.6
A412/5.5SR	NGA41205D5HSORA	13.0	9.8	8.2	6.9	5.3	4.2	3.3	2.2	1.5	1.2	1.0	0.7	0.5
A412/8.5SR	NGA41208D5HSORA	19.0	15.0	12.0	10.0	7.5	5.8	4.6	3.0	2.2	1.7	1.5	1.0	0.8
A412/12SR	NGA4120012HSORA	24.0	20.0	16.0	13.0	10.0	8.0	6.6	3.9	2.9	2.3	1.9	1.4	1.2
A412/20G5	NGA4120020HSOBA	45.0	34.0	27.0	23.0	18.0	15.0	12.0	7.0	5.0	3.9	3.3	2.2	2.0
A412/32G6	NGA4120032HSOBA	73.0	57.0	46.0	39.0	31.0	24.0	19.0	12.0	8.8	6.9	5.8	3.9	3.2
A412/32F10	NGA4120032HSOFA	73.0	57.0	46.0	39.0	31.0	24.0	19.0	12.0	8.8	6.9	5.8	3.9	3.2
A412/50A	NGA4120050HSOCA	109.0	90.0	73.0	61.0	48.0	38.0	30.0	19.0	13.5	10.7	8.9	6.0	5.0
A412/50F10	NGA4120050HSOFA	109.0	90.0	73.0	61.0	48.0	38.0	30.0	19.0	13.5	10.7	8.9	6.0	5.0
A412/50G6	NGA4120050HSOBA	109.0	90.0	73.0	61.0	48.0	38.0	30.0	19.0	13.5	10.7	8.9	6.0	5.0
A412/65F10	NGA4120065HSOFA	134.0	107.0	84.0	70.0	56.0	48.0	41.0	24.0	17.1	13.6	11.4	7.7	6.5
A412/65G6	NGA4120065HSOBA	134.0	107.0	84.0	70.0	56.0	48.0	41.0	24.0	17.1	13.6	11.4	7.7	6.5
A412/85F10	NGA4120085HSOFB	170.0	140.0	118.0	100.0	79.0	63.0	51.0	32.0	22.7	17.9	14.9	10.0	8.5
A412/90A	NGA4120090HSOCA	186.0	154.0	128.0	108.0	84.0	64.0	52.0	33.0	24.1	18.8	15.8	11.0	9.0
A412/90F10	NGA4120090HSOFA	186.0	154.0	128.0	108.0	84.0	64.0	52.0	33.0	24.1	18.8	15.8	11.0	9.0
A412/100A	NGA4120100HSOCA	194.0	160.0	134.0	112.0	86.0	65.0	52.0	33.0	24.8	19.2	16.3	11.4	10.0
A412/100F10	NGA4120100HSOFA	194.0	160.0	134.0	112.0	86.0	65.0	52.0	33.0	24.8	19.2	16.3	11.4	10.0
A412/120A	NGA4120120HSOCA	233.0	174.0	145.0	127.0	106.0	88.0	69.0	40.0	29.1	23.3	19.5	13.2	12.0
A412/120F10	NGA4120120HSOFA	233.0	174.0	145.0	127.0	106.0	88.0	69.0	40.0	29.1	23.3	19.5	13.2	12.0
A412/180A	NGA4120180HSOCA	329.0	266.0	216.0	185.0	152.0	117.0	94.0	63.0	45.6	36.1	30.2	20.2	18.0
A412/180F10	NGA4120180HSOFA	329.0	266.0	216.0	185.0	152.0	117.0	94.0	63.0	45.6	36.1	30.2	20.2	18.0

1.70 V/C – Discharge in A at 20°C

Type	Part number	5min	10min	15min	20min	30min	45min	1h	2h	3h	4h	5h	8h	10h
A406/165A	NGA4060165HSOCA	332.0	273.0	233.0	198.0	152.0	119.0	94.0	58.0	44.0	34.6	28.7	19.1	16.6
A406/165F10	NGA4060165HSOFA	332.0	273.0	233.0	198.0	152.0	119.0	94.0	58.0	44.0	34.6	28.7	19.1	16.6
A412/5.5SR	NGA41205D5HSORA	14.3	10.3	8.6	7.2	5.5	4.3	3.4	2.2	1.6	1.2	1.0	0.7	0.5
A412/8.5SR	NGA41208D5HSORA	21.0	15.0	12.0	10.0	7.6	5.9	4.7	3.0	2.2	1.7	1.5	1.0	0.8
A412/12SR	NGA4120012HSORA	28.0	21.0	16.0	13.0	10.0	8.0	6.8	4.0	2.9	2.3	2.0	1.4	1.2
A412/20G5	NGA4120020HSOBA	51.0	38.0	29.0	24.0	19.0	15.0	12.0	7.0	5.0	4.0	3.3	2.2	2.0
A412/32G6	NGA4120032HSOBA	84.0	61.0	50.0	42.0	32.0	25.0	20.0	12.0	8.9	7.0	5.8	3.9	3.2
A412/32F10	NGA4120032HSOFA	84.0	60.0	50.0	42.0	32.0	25.0	20.0	12.0	8.9	7.0	5.8	3.9	3.2
A412/50A	NGA4120050HSOCA	122.0	94.0	77.0	64.0	49.0	39.0	31.0	19.0	13.6	10.7	8.9	6.0	5.0
A412/50F10	NGA4120050HSOFA	122.0	94.0	77.0	64.0	49.0	39.0	31.0	19.0	13.6	10.7	8.9	6.0	5.0
A412/50G6	NGA4120050HSOBA	122.0	94.0	77.0	64.0	49.0	39.0	31.0	19.0	13.6	10.7	8.9	6.0	5.0
A412/65F10	NGA4120065HSOFA	148.0	111.0	89.0	73.0	57.0	49.0	41.0	24.0	17.3	13.7	11.5	7.7	6.5
A412/65G6	NGA4120065HSOBA	148.0	111.0	89.0	73.0	57.0	49.0	41.0	24.0	17.3	13.7	11.5	7.7	6.5
A412/85F10	NGA4120085HSOFB	192.0	151.0	127.0	106.0	82.0	64.0	52.0	32.0	22.8	17.9	14.9	10.0	8.5
A412/90A	NGA4120090HSOCA	206.0	164.0	137.0	113.0	87.0	66.0	53.0	33.0	24.3	18.9	16.3	11.0	9.0
A412/90F10	NGA4120090HSOFA	206.0	164.0	137.0	113.0	87.0	66.0	53.0	33.0	24.3	18.9	16.3	11.0	9.0
A412/100A	NGA4120100HSOCA	213.0	171.0	141.0	117.0	89.0	67.0	53.0	34.0	25.1	19.4	17.0	11.4	10.0
A412/100F10	NGA4120100HSOFA	213.0	171.0	141.0	117.0	89.0	67.0	53.0	34.0	25.1	19.4	17.0	11.4	10.0
A412/120A	NGA4120120HSOCA	280.0	200.0	160.0	136.0	109.0	90.0	70.0	40.0	29.3	23.4	19.6	13.2	12.0
A412/120F10	NGA4120120HSOFA	280.0	200.0	160.0	136.0	109.0	90.0	70.0	40.0	29.3	23.4	19.6	13.2	12.0
A412/180A	NGA4120180HSOCA	366.0	287.0	234.0	199.0	156.0	120.0	95.0	64.0	46.0	36.4	30.4	20.2	18.0
A412/180F10	NGA4120180HSOFA	366.0	287.0	234.0	199.0	156.0	120.0	95.0	64.0	46.0	36.4	30.4	20.2	18.0

1.65 V/C – Discharge in A at 20°C											
Type	Part number	5min	10min	15min	20min	30min	45min	1h	2h	3h	4h
A406/165A	NGA4060165HSOCA	389.0	301.0	248.0	210.0	157.0	121.0	95.0	59.0	43.9	34.5
A406/165F10	NGA4060165HSOFA	389.0	301.0	248.0	210.0	157.0	121.0	95.1	59.0	43.9	34.5
A412/5.5SR	NGA41205D5HSORA	15.5	10.7	8.7	7.3	5.6	4.3	3.4	2.2	1.6	1.2
A412/8.5SR	NGA41208D5HSORA	23.0	16.0	12.0	10.0	7.7	6.0	4.7	3.0	2.2	1.7
A412/12SR	NGA4120012HSORA	30.0	22.0	17.0	14.0	11.0	9.0	6.8	4.0	2.9	2.3
A412/20G5	NGA4120020HSOBA	56.0	40.0	31.0	25.0	19.0	15.0	12.0	7.0	5.0	4.0
A412/32G6	NGA4120032HSOBA	94.0	65.0	52.0	43.0	33.0	25.0	20.0	12.0	8.9	7.0
A412/32F10	NGA4120032HSOFA	94.0	65.0	52.0	43.0	33.0	25.0	20.0	12.0	8.9	7.0
A412/50A	NGA4120050HSOCA	133.0	98.0	79.0	66.0	50.0	39.0	31.0	19.0	13.6	10.7
A412/50F10	NGA4120050HSOFA	133.0	98.0	79.0	66.0	50.0	39.0	31.0	19.0	13.6	10.7
A412/50G6	NGA4120050HSOBA	133.0	98.0	79.0	66.0	50.0	39.0	31.0	19.0	13.6	10.7
A412/65F10	NGA4120065HSOFA	161.0	114.0	91.0	75.0	57.0	49.0	42.0	24.0	17.3	13.7
A412/65G6	NGA4120065HSOBA	161.0	114.0	91.0	75.0	57.0	49.0	42.0	24.0	17.3	13.7
A412/85F10	NGA4120085HSOFB	210.0	159.0	134.0	110.0	84.0	65.0	52.0	32.0	22.8	17.9
A412/90A	NGA4120090HSOCA	225.0	172.0	142.0	116.0	88.0	67.0	53.0	33.0	24.5	19.0
A412/90F10	NGA4120090HSOFA	225.0	172.0	142.0	116.0	88.0	67.0	53.0	33.0	24.5	19.0
A412/100A	NGA4120100HSOCA	232.0	178.0	146.0	120.0	90.0	68.0	54.0	34.0	25.3	19.5
A412/100F10	NGA4120100HSOFA	232.0	178.0	146.0	120.0	90.0	68.0	54.0	34.0	25.3	19.5
A412/120A	NGA4120120HSOCA	311.0	217.0	169.0	142.0	111.0	91.0	71.0	41.0	29.4	23.4
A412/120F10	NGA4120120HSOFA	311.0	217.0	169.0	142.0	111.0	91.0	71.0	41.0	29.4	23.4
A412/180A	NGA4120180HSOCA	399.0	305.0	250.0	212.0	159.0	122.0	96.0	64.0	46.0	36.4
A412/180F10	NGA4120180HSOFA	399.0	305.0	250.0	212.0	159.0	122.0	96.0	64.0	46.0	36.4

1.60 V/C – Discharge in A at 20°C											
Type	Part number	5min	10min	15min	20min	30min	45min	1h	2h	3h	4h
A406/165A	NGA4060165HSOCA	422.0	318.0	256.0	215.0	160.0	122.0	96.0	59.0	44.0	34.6
A406/165F10	NGA4060165HSOFA	422.0	318.0	256.0	215.0	160.0	122.0	96.0	59.0	44.0	34.6
A412/5.5SR	NGA41205D5HSORA	16.1	11.0	8.9	7.5	5.6	4.4	3.4	2.2	1.6	1.2
A412/8.5SR	NGA41208D5HSORA	24.0	16.0	13.0	10.0	7.8	6.0	4.8	3.0	2.2	1.7
A412/12SR	NGA4120012HSORA	33.0	23.0	17.0	14.0	11.0	9.0	6.8	4.0	2.9	2.3
A412/20G5	NGA4120020HSOBA	60.0	42.0	31.0	26.0	19.0	15.0	12.0	7.0	5.0	4.0
A412/32G6	NGA4120032HSOBA	101.0	68.0	54.0	44.0	33.0	25.0	20.0	12.0	8.9	7.0
A412/32F10	NGA4120032HSOFA	101.0	68.0	54.0	44.0	33.0	25.0	20.0	12.0	8.9	7.0
A412/50A	NGA4120050HSOCA	144.0	101.0	81.0	67.0	51.0	40.0	31.0	19.0	13.6	10.7
A412/50F10	NGA4120050HSOFA	144.0	101.0	81.0	67.0	51.0	40.0	31.0	19.0	13.6	10.7
A412/50G6	NGA4120050HSOBA	144.0	101.0	81.0	67.0	51.0	40.0	31.0	19.0	13.6	10.7
A412/65F10	NGA4120065HSOFA	170.0	116.0	92.0	76.0	58.0	49.0	42.0	24.0	17.3	13.8
A412/65G6	NGA4120065HSOBA	170.0	116.0	92.0	76.0	58.0	49.0	42.0	24.0	17.3	13.8
A412/85F10	NGA4120085HSOFB	229.0	166.0	137.0	113.0	85.0	66.0	52.0	32.0	22.8	18.0
A412/90A	NGA4120090HSOCA	245.0	177.0	145.0	118.0	89.0	68.0	54.0	34.0	24.5	19.0
A412/90F10	NGA4120090HSOFA	245.0	177.0	145.0	118.0	89.0	68.0	54.0	34.0	24.5	19.0
A412/100A	NGA4120100HSOCA	253.0	183.0	149.0	121.0	91.0	69.0	54.0	34.0	25.4	19.6
A412/100F10	NGA4120100HSOFA	253.0	183.0	149.0	121.0	91.0	69.0	54.0	34.0	25.4	19.6
A412/120A	NGA4120120HSOCA	333.0	228.0	175.0	146.0	112.0	91.0	71.0	41.0	29.5	23.4
A412/120F10	NGA4120120HSOFA	333.0	228.0	175.0	146.0	112.0	91.0	71.0	41.0	29.5	23.4
A412/180A	NGA4120180HSOCA	439.0	322.0	258.0	217.0	162.0	123.0	96.0	64.0	46.1	36.4
A412/180F10	NGA4120180HSOFA	439.0	322.0	258.0	217.0	162.0	123.0	96.0	64.0	46.1	36.4

The values are measured at 20°C and may change depending on the application or ambient temperature.

1.85 V/C – Discharge in W/block at 20°C													
Type	Part number	2min	3min	5min	7min	10min	15min	20min	30min	45min	1h	2h	3h
A406/165A	NGA4060165HSOCA	1310	1263	1171	1096	1005	875	798	690	543	459	293	222
A406/165F10	NGA4060165HSOFA	1310	1263	1171	1096	1005	875	798	690	543	459	293	222
A412/5.5SR	NGA41205D5HSORA	153	141	120	106	95	80	69	58	44	36	22	16
A412/8.5SR	NGA41208D5HSORA	216	201	176	159	141	117	102	84	65	54	31	22
A412/12SR	NGA4120012HSORA	252	239	219	203	185	157	141	115	89	75	38	29
A412/20G5	NGA4120020HSOBA	438	414	378	348	302	257	229	195	151	126	71	51
A412/32G6	NGA4120032HSOBA	680	634	580	532	483	414	366	304	234	194	128	92
A412/32F10	NGA4120032HSOFA	680	634	580	532	483	414	366	304	234	194	128	92
A412/50A	NGA4120050HSOCA	1149	1075	1002	949	876	785	699	590	458	376	193	139
A412/50F10	NGA4120050HSOFA	1149	1075	1002	949	876	785	699	590	458	376	193	139
A412/50G6	NGA4120050HSOBA	1149	1075	1002	949	876	785	699	590	458	376	193	139
A412/65F10	NGA4120065HSOFA	1440	1342	1221	1137	1025	867	759	635	482	396	239	175
A412/65G6	NGA4120065HSOBA	1440	1342	1221	1137	1025	867	759	635	482	396	239	175
A412/85F10	NGA4120085HSOFB	1311	1275	1230	1158	1071	953	865	761	592	495	324	233
A412/90A	NGA4120090HSOCA	1686	1620	1493	1374	1243	1080	987	828	647	543	332	246
A412/90F10	NGA4120090HSOFA	1686	1620	1493	1374	1243	1080	987	828	647	543	332	246
A412/100A	NGA4120100HSOCA	1873	1792	1625	1482	1329	1144	1048	861	674	567	335	252
A412/100F10	NGA4120100HSOFA	1873	1792	1625	1482	1329	1144	1048	861	674	567	335	252
A412/120A	NGA4120120HSOCA	2418	2254	1964	1773	1575	1385	1272	1109	914	745	410	300
A412/120F10	NGA4120120HSOFA	2418	2254	1964	1773	1575	1385	1272	1109	914	745	410	300
A412/180A	NGA4120180HSOCA	3475	3324	3112	2959	2679	2284	2011	1563	1215	1016	632	467
A412/180F10	NGA4120180HSOFA	3475	3324	3112	2959	2679	2284	2011	1563	1215	1016	632	467

1.80 V/C – Discharge in W/block at 20°C													
Type	Part number	2min	3min	5min	7min	10min	15min	20min	30min	45min	1h	2h	3h
A406/165A	NGA4060165HSOCA	1622	1548	1414	1315	1184	1020	901	769	596	494	318	241
A406/165F10	NGA4060165HSOFA	1622	1548	1414	1315	1184	1020	901	769	596	494	318	241
A412/5.5SR	NGA41205D5HSORA	174	161	140	122	106	88	74	62	47	38	24	17
A412/8.5SR	NGA41208D5HSORA	246	232	204	180	156	130	111	90	69	56	33	24
A412/12SR	NGA4120012HSORA	314	292	258	235	208	177	153	125	96	79	42	31
A412/20G5	NGA4120020HSOBA	566	521	467	421	359	292	252	208	160	131	77	55
A412/32G6	NGA4120032HSOBA	826	764	677	622	562	468	403	332	252	207	135	98
A412/32F10	NGA4120032HSOFA	826	764	677	622	562	468	403	332	252	207	135	98
A412/50A	NGA4120050HSOCA	1385	1269	1135	1041	969	862	770	626	493	400	210	151
A412/50F10	NGA4120050HSOFA	1385	1269	1135	1041	969	862	770	626	493	400	210	151
A412/50G6	NGA4120050HSOBA	1385	1269	1135	1041	969	862	770	626	493	400	210	151
A412/65F10	NGA4120065HSOFA	1702	1601	1430	1296	1158	977	834	690	516	420	260	190
A412/65G6	NGA4120065HSOBA	1702	1601	1430	1296	1158	977	834	690	516	420	260	190
A412/85F10	NGA4120085HSOFB	1667	1573	1463	1375	1276	1082	960	804	637	527	352	253
A412/90A	NGA4120090HSOCA	1940	1848	1706	1554	1395	1185	1062	891	692	574	360	267
A412/90F10	NGA4120090HSOFA	1940	1848	1706	1554	1395	1185	1062	891	692	574	360	267
A412/100A	NGA4120100HSOCA	2076	1986	1828	1644	1454	1236	1112	935	719	597	364	274
A412/100F10	NGA4120100HSOFA	2076	1986	1828	1644	1454	1236	1112	935	719	597	364	274
A412/120A	NGA4120120HSOCA	2958	2668	2286	2027	1769	1496	1346	1146	971	802	446	326
A412/120F10	NGA4120120HSOFA	2958	2668	2286	2027	1769	1496	1346	1146	971	802	446	326
A412/180A	NGA4120180HSOCA	4109	3898	3559	3336	3012	2595	2241	1756	1339	1105	687	507
A412/180F10	NGA4120180HSOFA	4109	3898	3559	3336	3012	2595	2241	1756	1339	1105	687	507

1.75 V/C – Discharge in W/block at 20°C													
Type	Part number	2min	3min	5min	7min	10min	15min	20min	30min	45min	1h	2h	3h
A406/165A	NGA4060165HSOCA	1850	1781	1629	1493	1356	1146	981	797	623	512	337	247
A406/165F10	NGA4060165HSOFA	1850	1781	1629	1493	1356	1146	981	797	623	512	337	247
A412/5.5SR	NGA41205D5HSORA	196	178	155	134	114	93	78	63	49	40	24	17
A412/8.5SR	NGA41208D5HSORA	278	259	226	198	171	138	116	94	71	58	34	25
A412/12SR	NGA4120012HSORA	355	331	296	262	233	193	164	131	99	81	45	33
A412/20G5	NGA4120020HSOBA	658	596	518	467	398	315	267	213	164	135	77	56
A412/32G6	NGA4120032HSOBA	959	881	776	691	613	509	431	350	263	215	139	99
A412/32F10	NGA4120032HSOFA	959	881	776	691	613	509	431	350	263	215	139	99
A412/50A	NGA4120050HSOCA	1591	1480	1293	1148	1032	923	819	653	511	413	215	152
A412/50F10	NGA4120050HSOFA	1591	1480	1293	1148	1032	923	819	653	511	413	215	152
A412/50G6	NGA4120050HSOBA	1591	1480	1293	1148	1032	923	819	653	511	413	215	152
A412/65F10	NGA4120065HSOFA	1968	1830	1620	1447	1268	1054	886	714	534	432	270	193
A412/65G6	NGA4120065HSOBA	1968	1830	1620	1447	1268	1054	886	714	534	432	270	193
A412/85F10	NGA4120085HSOFB	1908	1826	1674	1532	1421	1200	1034	838	664	545	360	256
A412/90A	NGA4120090HSOCA	2301	2185	1984	1796	1564	1299	1128	927	716	590	375	272
A412/90F10	NGA4120090HSOFA	2301	2185	1984	1796	1564	1299	1128	927	716	590	375	272
A412/100A	NGA4120100HSOCA	2498	2364	2139	1928	1636	1348	1176	972	742	613	383	280
A412/100F10	NGA4120100HSOFA	2498	2364	2139	1928	1636	1348	1176	972	742	613	383	280
A412/120A	NGA4120120HSOCA	3453	3084	2593	2262	1940	1610	1387	1176	997	829	460	329
A412/120F10	NGA4120120HSOFA	3453	3084	2593	2262	1940	1610	1387	1176	997	829	460	329
A412/180A	NGA4120180HSOCA	4556	4307	3950	3659	3316	2821	2399	1876	1414	1157	695	515
A412/180F10	NGA4120180HSOFA	4556	4307	3950	3659	3316	2821	2399	1876	1414	1157	695	515

1.70 V/C – Discharge in W/block at 20°C													
Type	Part number	2min	3min	5min	7min	10min	15min	20min	30min	45min	1h	2h	3h
A406/165A	NGA4060165HSOCA	1993	1913	1778	1636	1455	1230	1036	814	637	522	339	247
A406/165F10	NGA4060165HSOFA	1993	1913	1778	1636	1455	1230	1036	814	637	522	339	247
A412/5.5SR	NGA41205D5HSORA	219	194	163	143	119	97	81	64	50	40	24	18
A412/8.5SR	NGA41208D5HSORA	306	283	246	212	178	143	120	95	72	58	34	25
A412/12SR	NGA4120012HSORA	394	366	323	286	247	203	170	135	101	82	45	33
A412/20G5	NGA4120020HSOBA	741	657	555	494	424	331	277	216	166	136	78	56
A412/32G6	NGA4120032HSOBA	1064	990	861	752	639	537	450	358	269	219	139	100
A412/32F10	NGA4120032HSOFA	1064	990	861	752	639	537	450	358	269	219	139	100
A412/50A	NGA4120050HSOCA	1734	1584	1406	1234	1079	956	849	669	520	419	216	153
A412/50F10	NGA4120050HSOFA	1734	1584	1406	1234	1079	956	849	669	520	419	216	153
A412/50G6	NGA4120050HSOBA	1734	1584	1406	1234	1079	956	849	669	520	419	216	153
A412/65F10	NGA4120065HSOFA	2191	2009	1762	1570	1323	1100	916	723	541	437	270	194
A412/65G6	NGA4120065HSOBA	2191	2009	1762	1570	1323	1100	916	723	541	437	270	194
A412/85F10	NGA4120085HSOFB	2076	1987	1837	1671	1510	1276	1084	862	679	554	362	256
A412/90A	NGA4120090HSOCA	2553	2398	2177	1950	1670	1368	1172	945	727	598	375	273
A412/90F10	NGA4120090HSOFA	2553	2398	2177	1950	1670	1368	1172	945	727	598	375	273
A412/100A	NGA4120100HSOCA	2792	2604	2347	2090	1749	1414	1216	987	752	620	385	282
A412/100F10	NGA4120100HSOFA	2792	2604	2347	2090	1749	1414	1216	987	752	620	385	282
A412/120A	NGA4120120HSOCA	3821	3501	2938	2497	2090	1699	1441	1195	1008	840	460	330
A412/120F10	NGA4120120HSOFA	3821	3501	2938	2497	2090	1699	1441	1195	1008	840	460	330
A412/180A	NGA4120180HSOCA	4990	4742	4298	3929	3477	2976	2503	1945	1455	1185	697	517
A412/180F10	NGA4120180HSOFA	4990	4742	4298	3929	3477	2976	2503	1945	1455	1185	697	517

The values are measured at 20°C and may change depending on the application or ambient temperature.

1.65 V/C – Discharge in W/block at 20°C													
Type	Part number	2min	3min	5min	7min	10min	15min	20min	30min	45min	1h	2h	3h
A406/165A	NGA4060165HSOCA	2162	2055	1879	1734	1527	1278	1067	828	643	525	341	248
A406/165F10	NGA4060165HSOFA	2162	2055	1879	1734	1527	1278	1067	828	643	525	341	248
A412/5.5SR	NGA41205D5HSORA	235	208	169	149	123	99	82	65	51	41	24	18
A412/8.5SR	NGA41208D5HSORA	331	306	258	222	183	146	122	96	72	59	34	25
A412/12SR	NGA4120012HSORA	436	399	348	304	255	209	174	136	102	83	45	33
A412/20G5	NGA4120020HSOBA	799	701	583	511	439	339	282	218	167	136	79	56
A412/32G6	NGA4120032HSOBA	1161	1069	916	801	667	554	462	362	273	221	139	100
A412/32F10	NGA4120032HSOFA	1161	1069	916	801	667	554	462	362	273	221	139	100
A412/50A	NGA4120050HSOCA	1931	1747	1480	1309	1120	991	866	677	524	422	217	153
A412/50F10	NGA4120050HSOFA	1931	1747	1480	1309	1120	991	866	677	524	422	217	153
A412/50G6	NGA4120050HSOBA	1931	1747	1480	1309	1120	991	866	677	524	422	217	153
A412/65F10	NGA4120065HSOFA	2419	2214	1874	1658	1371	1125	932	727	545	439	271	195
A412/65G6	NGA4120065HSOBA	2419	2214	1874	1658	1371	1125	932	727	545	439	271	195
A412/85F10	NGA4120085HSOFB	2255	2139	1963	1770	1569	1326	1116	876	686	559	364	257
A412/90A	NGA4120090HSOCA	2824	2598	2305	2067	1744	1415	1200	954	732	601	376	274
A412/90F10	NGA4120090HSOFA	2824	2598	2305	2067	1744	1415	1200	954	732	601	376	274
A412/100A	NGA4120100HSOCA	3108	2827	2475	2216	1831	1459	1242	993	756	623	387	283
A412/100F10	NGA4120100HSOFA	3108	2827	2475	2216	1831	1459	1242	993	756	623	387	283
A412/120A	NGA4120120HSOCA	4111	3798	3170	2682	2194	1757	1474	1205	1012	845	460	331
A412/120F10	NGA4120120HSOFA	4111	3798	3170	2682	2194	1757	1474	1205	1012	845	460	331
A412/180A	NGA4120180HSOCA	5419	5099	4628	4163	3589	3074	2565	1978	1475	1198	700	518
A412/180F10	NGA4120180HSOFA	5419	5099	4628	4163	3589	3074	2565	1978	1475	1198	700	518

1.60 V/C – Discharge in W/block at 20°C													
Type	Part number	2min	3min	5min	7min	10min	15min	20min	30min	45min	1h	2h	3h
A406/165A	NGA4060165HSOCA	2351	2202	1987	1828	1588	1308	1086	836	646	527	342	249
A406/165F10	NGA4060165HSOFA	2351	2202	1987	1828	1588	1308	1086	836	646	527	342	249
A412/5.5SR	NGA41205D5HSORA	248	220	175	153	125	100	83	65	51	41	24	18
A412/8.5SR	NGA41208D5HSORA	354	325	267	228	187	148	123	97	72	59	34	25
A412/12SR	NGA4120012HSORA	474	424	358	317	263	213	176	137	102	83	45	33
A412/20G5	NGA4120020HSOBA	874	760	610	521	447	343	285	219	168	136	80	56
A412/32G6	NGA4120032HSOBA	1245	1143	952	835	687	565	469	366	276	223	140	101
A412/32F10	NGA4120032HSOFA	1245	1143	952	835	687	565	469	366	276	223	140	101
A412/50A	NGA4120050HSOCA	2216	1989	1583	1363	1151	1001	875	682	526	423	218	154
A412/50F10	NGA4120050HSOFA	2216	1989	1583	1363	1151	1001	875	682	526	423	218	154
A412/50G6	NGA4120050HSOBA	2216	1989	1583	1363	1151	1001	875	682	526	423	218	154
A412/65F10	NGA4120065HSOFA	2603	2402	1962	1713	1400	1137	940	729	547	440	272	196
A412/65G6	NGA4120065HSOBA	2603	2402	1962	1713	1400	1137	940	729	547	440	272	196
A412/85F10	NGA4120085HSOFB	2431	2280	2058	1868	1609	1357	1136	885	690	562	365	257
A412/90A	NGA4120090HSOCA	3046	2755	2398	2157	1793	1444	1217	961	736	604	377	275
A412/90F10	NGA4120090HSOFA	3046	2755	2398	2157	1793	1444	1217	961	736	604	377	275
A412/100A	NGA4120100HSOCA	3354	2992	2567	2301	1885	1488	1258	999	759	625	388	284
A412/100F10	NGA4120100HSOFA	3354	2992	2567	2301	1885	1488	1258	999	759	625	388	284
A412/120A	NGA4120120HSOCA	4297	3942	3330	2779	2260	1791	1494	1210	1014	847	460	332
A412/120F10	NGA4120120HSOFA	4297	3942	3330	2779	2260	1791	1494	1210	1014	847	460	332
A412/180A	NGA4120180HSOCA	5825	5395	4832	4361	3701	3130	2599	1994	1484	1204	702	519
A412/180F10	NGA4120180HSOFA	5825	5395	4832	4361	3701	3130	2599	1994	1484	1204	702	519

Exide Technologies Industrial Energy – The Industry Leader.



Exide Technologies Industrial Energy is a global leader in stored electrical energy solutions for all major critical reserve power applications and needs. Standby power applications include communication/data networks, UPS systems for computers and control systems, electrical power generation and distribution systems, as well as a wide range of other industrial standby power applications. With a strong manufacturing base in both North America and Europe and a truly global reach (operations in more than 80 countries) in sales and service, Exide Technologies Industrial Energy is best positioned to satisfy your back up power needs locally as well as all over the world.

Based on over 100 years of technological innovation the Industrial Energy Division leads the industry with the most recognized global standby power brands such as Absolyte, Sonnenschein, Marathon, Sprinter, and Flooded Classic. They have come to symbolize quality, reliability, performance and excellence in all the markets served.

Exide Technologies takes pride in its commitment to a better environment. Its Total Battery Management program, an integrated approach to manufacturing, distributing and recycling of lead acid batteries, has been developed to ensure a safe and responsible life cycle for all of its products.

EXIDE Technologies
Industrial Energy
Im Thiergarten
63654 Büdingen
Germany
Tel.: +49 (0)60 42/81 70
Fax: +49 (0)60 42/81 233

EXIDE Technologies
Industrial Energy
3950 Sussex Avenue
Aurora, IL, U.S.A.
Tel.: +1 630.862.2200
Fax: +1 630.862.2312

www.networkpower.exide.com

EXIDE
TECHNOLOGIES