



THROUGH CARING WE LEAD™



AUTOMOTIVE BATTERY TRAINING MANUAL FLOODED BATTERIES



ISO 14001: 2004
ISO 9001: 2000
ISO/TS 16949:2002



Pb.

CONTENTS

	Page
SAFETY PRECAUTIONS	1
HOW A BATTERY WORKS	2
BATTERY CONSTRUCTION	3
BATTERY RATINGS	5
EFFECTS DURING DISCHARGE	6
EFFECTS DURING CHARGING	7
BATTERY CARE AND MAINTENANCE	8
COMMON BATTERY CAUSES OF FAILURE	9
NEW BATTERY INSTALLATION	10
TESTING	11
CLAIMS ADJUDICATION PROCEDURES	12
WARRANTY ASSESSMENT WITHOUT 'SMART TESTER'	14
BACK TO BATTERY BASICS - THE POWER TEAM	16
SULPHURIC ACID	17
LEISURE BATTERY RANGE	18
TWIN BATTERY SETUPS	19
JUMP STARTING	21
WARRANTY & CLAIMS DOCUMENTATION PROCEDURE	21
STARTER BATTERY WARRANTY	22
LEISURE BATTERY WARRANTY	23
SMF 100/101 BATTERY WARRANTY	24
MOTORCYCLE BATTERY WARRANTY	25

The wording, artwork and trade marks used herein are the subjects of statutory protection including copyright in the name of First National Battery Company, Division of Metindustrial (Pty) Ltd. All rights herein are reserved and no part of this Automotive Battery Training Manual may be reproduced or transmitted in any form or by any means howsoever and whether electronically or mechanically and including photocopying, recording or by any information storage or retrieval system, without the prior written permission from First National Battery Company, Division of Metindustrial (Pty) Ltd.

The information appearing in this Automotive Battery Training Manual is intended to be of a general nature only and whilst every effort has been made to include accurate and current information, errors can occur. The information herein contained is intended as a guide only and relevant professional advice must be taken should a definitive analysis of any particular problem be required. First National Battery Company, Division of Metindustrial (Pty) Ltd. accordingly disclaims any responsibility / liability for any loss, damage, injury or expense howsoever arising out of or in connection with the use of or the reliance upon the information so provided or the omission thereof and/or any errors herein contained. Please note that certain brands of products as identified herein may only be available for supply in certain territories in the sole discretion of First National Battery Company, Division of Metindustrial (Pty) Ltd.

We acknowledge with thanks the use of certain BCI illustrations.

SAFETY PRECAUTIONS

Batteries contain dilute sulphuric acid. They also emit hydrogen gas which can produce an explosive mixture. Therefore this first section of the manual deals with safety precautions to be followed when working with batteries. Specific safety precautions will be mentioned throughout the manual where applicable.

HANDLING BATTERY ACID

When working with acid wear a face shield and protective clothing.

Use extreme care to avoid spillage or splashing as it can destroy clothing and if not treated promptly cause damage to the skin. Be especially cautious when lifting batteries with polypropylene containers as pressure on the end walls could result in acid being ejected through the vent plugs. If acid is spilt onto clothing or the skin it should be neutralised immediately using a solution of baking soda or household ammonia and water and then rinsed using clean water.

If acid enters the eye, force the eye open and flood with cool, clean water for approximately fifteen minutes. If acid is swallowed drink large quantities of water or milk. Follow with milk of magnesia. Obtain medical advice as soon as possible. Do not encourage vomiting.

Electrolyte spilt on the surface of the car should be neutralised and rinsed with clean water. We do not recommend the dilution of concentrated sulphuric acid by non-qualified personnel. In any event, batteries are supplied in a filled and charged condition and should never require acid to be added except in the case of spillage. Under such circumstances advice should be sought from the battery manufacturer.

DANGER OF EXPLOSIONS

BATTERIES PRODUCE EXPLOSIVE GASES. KEEP SPARKS, FLAMES, BURNING CIGARETTES OR OTHER IGNITION SOURCES AWAY FROM THE BATTERY AT ALL TIMES. ALWAYS WEAR SAFETY GOGGLES OR A FACE SHIELD WHEN WORKING NEAR BATTERIES.

Only allow trained personnel to work on a battery. They should know and observe the safety precautions detailed in this manual. They should be familiar with the procedures to be followed if they attempt to charge or test a battery or jump start a vehicle. The manufacturer's instructions must be followed when any equipment such as a charger or tester is used. Hydrogen and oxygen are produced as a part of the operation of the battery. These gases produce an explosive mixture within the battery and escape through the vents. Many modern batteries incorporate a flame arrester but it is still essential to keep any form of ignition well away from the battery. An exploding battery can cause severe injury from flying pieces of container and acid. Always wear safety goggles or a face shield when working near a battery. Avoid leaning over the battery when charging, testing, 'jump starting', connecting or disconnecting. Do not break 'live' circuits at the terminals of the battery as this invariably causes a spark to be produced at the point where the circuit is broken. Ensure that the charger cable clamps or 'jump start' leads are in good order and the connections are good. A poor connection can cause an electrical arc which can ignite the hydrogen gas and cause an explosion.

Avoid dropping tools across the terminals and use insulated spanners. Do not smoke or bring any naked flame near the battery.

CHARGING A BATTERY

The battery should be charged in a well ventilated area. Do not remove the vent plugs during charge except when taking readings of specific gravity or topping up, if required.

Follow the charger manufacturer's instructions.

Make sure that the charger is switched off before connecting to the battery. Connect the charger leads to the battery terminals with the red positive (+) lead to the positive terminal and the black or blue negative (-) lead to the negative terminal. The battery should not be charged whilst still connected to the

vehicle as the voltages reached during charge can damage the vehicle's electrical system.

Never touch the charger leads while the charger is switched on. This could break the circuit creating a spark which could result in an explosion.

JUMP STARTING AN ENGINE (Refer to page 16)

Each step in the procedure "Jump Starting" as described on page 16 must be followed carefully. Failure to do so could result in a) acid damage due to gushing of electrolyte through the vents, b) explosion of one of the batteries or c) damage to the electrical system of one or both vehicles.

HOW A BATTERY WORKS

When two dissimilar conducting materials (electrodes) are immersed in a solution capable of conducting electricity (an electrolyte) one will become positively charged and the other negatively. The ends of the electrodes protruding above the electrolyte are known as the positive and negative terminals and the whole unit is called a cell. Connecting the terminals with a wire will cause an electrical current to flow through the wire from the negative to the positive terminal.

The potential difference or electrical pressure between the terminals is dependent upon the materials of the electrodes and the electrolyte and is measured in volts.

PRIMARY CELLS

In a torch battery the electrodes comprise the positive carbon rod in the centre of the cell and the negative zinc container with a jelly electrolyte of ammonium chloride. The potential of the cell is approximately 1.5 volts. During use the zinc is slowly dissolved in the production of the current, and when it or the ammonium chloride is exhausted, the flow of current ceases and the cell must be discarded. Such cells are termed primary or non-rechargeable.

SECONDARY CELLS

The lead acid cell belongs to the group termed secondary or re-chargeable. Here the electrodes are a lead dioxide positive, and a sponge lead negative with a dilute sulphuric acid electrolyte. During discharge current flows and positive and negative electrodes convert to lead sulphate and absorb sulphate ions from the electrolyte reducing it to water. Unlike the torch cell, the lead-acid cell is reversible and may be restored to its original condition by passing electricity through the cell in the opposite direction from which it was removed. This reverses the reactions in the cell, converting the lead sulphate in the plates back into their original active materials and returning the sulphate ions to the electrolyte.

Lead acid cells have a potential of approximately 2 volts irrespective of size. Larger cells will have a higher capacity and deliver the same current for longer or higher current for the same period than smaller cells. Cells may be connected in series (i.e. the negative of one cell to the positive of the next) to give higher voltages. Thus three cells connected in series will give a "battery" of cells having a nominal voltage of 6 volts. Similarly six cells connected in series will produce a 12 volt battery.

PURPOSE OF THE BATTERY

The three main functions of the automotive battery are to:

- 1) Supply power to the starter and ignition system so that the engine can be cranked and started.
- 2) Supplement the electrical load when load requirements exceed the supply capability of the alternator. It also supplies power to the electrical system (parasitic loads) when the engine is switched off.
- 3) Act as a voltage stabiliser in the electrical system. The battery smooths out or reduces temporarily high voltages (transients) which may occur in the system, thereby protecting voltage sensitive components.

BATTERY CONSTRUCTION

CONTAINER

Locally manufactured - polypropylene (virgin and recycled material is used) - durable - heat and cold resistant - resists acid attack.

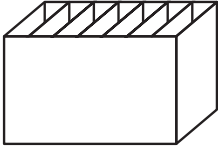

Cells are completely isolated from one another

THE GRIDS

Pure lead is too soft for grid manufacture, so it is alloyed with a small percentage of antimony for strength. The negative grids of the hybrid or calcium battery consist of a lead calcium alloy while the positive grids consist of a lead antimonial alloy. A calcium battery has both negative and positive grids manufactured from lead calcium alloys.

- The purpose of the grids is to provide a supporting **framework** for the active material and also to **conduct current**.
- Low water loss batteries have positive grids made from lead antimony alloys and negative grids from lead calcium alloys. Very low water loss batteries have both grids made from lead calcium alloys.
- Grid designs vary but generally place more metal where current density is greatest.

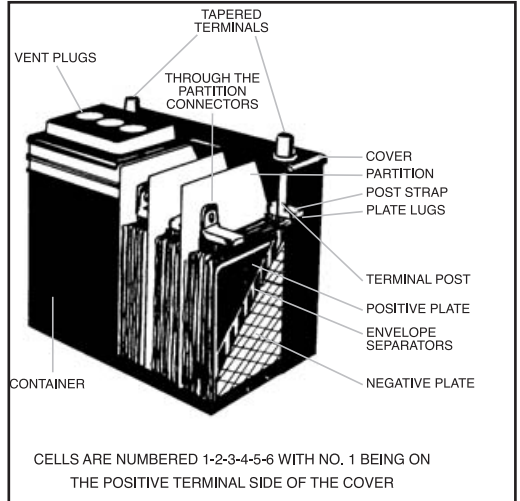

RECTILINEAR

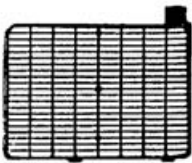

CENTRE LUG RADIAL

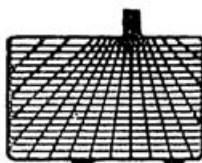

RADIAL

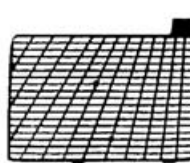

TREE

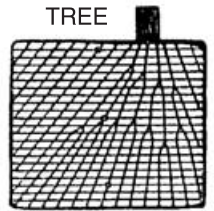

PASTING

The positive and negative plates are made by pasting the grids with a mixture of lead oxide, sulphuric acid and water.

- Fibre additives give cohesion (stickability) to keep active material particles connected together.
- Expanders are added to the negative plate paste to prevent the negative material from contracting during operation and changing into a dense inactive state, which would inhibit the constant chemical reaction in normal operation i.e. it keeps the plates spongy.
- The paste is mechanically applied and the plates then go on a conveyor through a flash drying oven which dries the surface of the plates to prevent them sticking together.

- Positive plates are now green to yellow
- Negative plates are slightly grey due to the carbon black in the expander materials
- The plates are stacked in a controlled temperature and humidity environment to cure. Curing stabilises the plates chemically. An exothermic reaction takes place, converting any free lead in the paste to lead oxide.

SEPARATORS (ENVELOPE)

Thin porous sheets with insulating abilities envelope positive plates to prevent shorting.

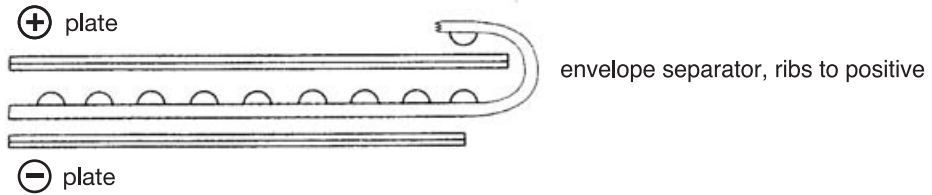

- Fine pores allow free electrolyte movement through the separators
- Ribs allow gas bubbles to surface and as the positive plate needs more electrolyte than the negative to operate, ribs point towards the positive plate.
- The most common separator in use is the envelope separator, where alternative plates are encased in a heat sealed polyethylene envelope. A technological breakthrough with many advantages.

ELEMENTS

- Stacks of varying numbers of negative and positive plates and separators are held together and the lugs are welded together to form cell packs called elements.
- It is customary to have a negative plate on each end of the element (STANDARD RATIO). When the end plates are positive we call it a REVERSE RATIO battery. When 1 end plate is positive and the other negative it is called an EVEN RATIO battery.
- Terminal posts are formed on the first and last cell elements.
- More plates = more surface area = higher cranking capacity.
- Cells are inserted into containers and welded through holes in the cell partitions in **series** leading to a low resistance path. Open circuit voltage is 2,1V per element - regardless of size.

Therefore 6 cells = 12,6

3 cells = 6,3 volts

- The cover with pre-cast ferrules is heat bonded to the container and filled with compressed air to check for leaks (ongoing quality control).
- Finally the two terminal posts are fused to the ferrules to form the terminals.

FORMING

- The battery is now ready for transport in a dry unformed state (green).
- 'Formation' is achieved by filling electrolyte into each cell and leaving it to saturate the plates. After this, the battery is put on charge for a specified time. The sulphuric acid in the electrolyte reacts with the lead oxide on both the positive and negative plates to form lead sulphate.
- Forming electrochemically changes the lead sulphate of the positive plates into lead dioxide (dark chocolate brown colour). At the same time the lead sulphate of the negative plate converts into a grey sponge lead.

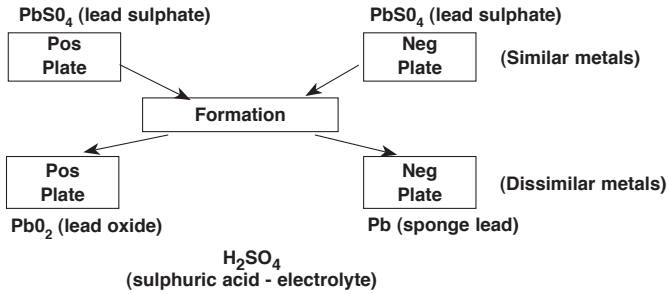

TERMINALS

- Tapered terminals are standard. Positive post top diameter is 17,5mm, i.e. slightly larger than negative post top diameter of 15,9mm.

BATTERY RATINGS

Automotive batteries are rated according to 3 different tests. The COLD CRANKING PERFORMANCE, the RESERVE CAPACITY and the 20-HOUR CAPACITY tests.

COLD CRANKING PERFORMANCE (IEC)

The primary function of the battery is to start the engine. It accomplishes this by rotating the crankshaft (cranking) and providing electrical power to activate the ignition system until the engine fires and starts. This requires a high current over a short period of time. Because the current requirement is higher when the engine is cold and the battery has less power when it is cold the cranking rating is defined as:

The discharge load in amperes which a battery at -18°C can deliver for 30s while meeting the following requirements:

$$10sV \geq 7.5V$$

$$30sV \geq 7.2V$$

Followed by a 20s rest and then another load at 60% of the original until the battery falls to 6.0V. Final requirement to be met is T (time) 6V ≥ 40s.

The "Cold Cranking Amperes" is often abbreviated to CCA's.

RESERVE CAPACITY

In the event of the charging system failing the battery may be called upon to provide the electrical power to enable the vehicle to be driven for a short distance. The Reserve Capacity gives an indication of the batteries ability to supply the minimum load under the worst conditions (i.e. winter driving at night). This could require current for ignition, low beam headlights, windscreen wipers and defrosting.

The Reserve Capacity Rating is defined as:

The number of minutes a new fully charged battery at 25°C can be discharged at 25 amperes to a minimum voltage of 1.75 volts per cell.

20-HOUR CAPACITY

The 20-hour capacity is the quantity of electricity that a battery at a temperature of 25°C can supply over a period of 20 hours while maintaining a voltage of greater than 1.75 volts per cell when discharged at C20/20. It is expressed in Ampere - hours (Ah).

EFFECTS DURING DISCHARGE

ELECTROLYTE

As the battery discharges, the sulphate ions from the acid combine with the lead and lead dioxide on the plates. The acid strength is thus reduced and the specific gravity (S.G.) decreases. If sufficient active material was present to consume all the sulphate ions the acid would ultimately be reduced to water. In the charged state the electrolyte has specific gravity of approximately 1.270 (S.G. is the ratio of the weight of 1l of sulphuric acid to the weight of 1l of water at the same temperature). When discharged the specific gravity of the electrolyte in the battery will have fallen to 1.150 or even lower. This change in S.G. is readily shown by testing the electrolyte with a hydrometer. The hydrometer reading indicates the state of charge of the battery by showing the amount of acid remaining in the electrolyte, the balance having been absorbed by the plates.

PLATES

The acid within the plates reacts with the sponge lead on the negative plates and the lead dioxide on the positive plates to form lead sulphate. The other product of the chemical reaction is water which then has to diffuse from the plates to allow for replacement acid to come into contact with the active material in order for the discharge to continue.

When a battery is discharged at a high rate, say 500 amps, the rate of usage of acid exceeds the rate of diffusion so that the battery voltage rapidly falls away.

At low rates of discharge diffusion is able to take place resulting in the current being maintained at a relatively constant voltage for long periods.

During discharge the lead sulphate is formed as minute crystals which are readily converted, when recharged, into their original components. If the plates are allowed to stand in a discharged state for prolonged periods the small crystals dissolve and deposit on larger ones causing them to grow. This process continues and the large crystals push against each other exerting enormous pressures resulting in distortion or buckling of the plates. In extreme cases the buckling may lead to the plates cutting through the separators causing short circuits. Even prior to the plates buckling it may become impossible to recharge the battery due to the poor conductivity of the large sulphate crystals.

TEMPERATURE

High temperatures increase the available output of the battery by increasing the rate of the chemical reactions and reducing the electrolyte density so that it penetrates the pores of the plates more readily. High temperatures also cause destructive attack on the positive grids and negative active material, thus shortening life. It is commonly accepted that an increase in average electrolyte temperature of 10°C will reduce the batteries life by half. In high temperature environments the destructive effects may be reduced by lowering the specific gravity of the electrolyte.

Low temperatures have the opposite effect on discharges resulting in the acid becoming denser and this makes it sluggish in penetrating the pores of the plates whilst the chemical reaction is slowed down. On the other hand, the attack on the battery components is reduced.

Whilst under normal circumstances the electrolyte will not freeze at low temperatures, the battery must not be allowed to discharge excessively as the weakened electrolyte could freeze.

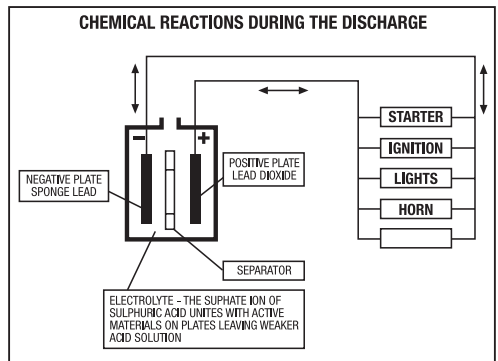

EFFECTS DURING CHARGING

ELECTROLYTE

As the battery is recharged sulphate ions are released from the plates and, because the resultant electrolyte is denser than the weakened electrolyte, falls to the bottom of the cell and does not mix with the electrolyte at the top. Therefore it will be found that the specific gravity does not increase for a long time after charging is started.

At commencement of charge the voltage of each cell is about 2.1 volts per cell and this slowly increases as the active materials accept the charge and convert from lead sulphate to sponge lead (negative) and lead dioxide (positive). When the cells reach a certain voltage gassing will commence (Hybrid batteries - 2.38V, calcium batteries - 2.47V, 20°C).

As the voltage of each cell exceeds 2.38V, oxygen gas is released from the positive active material (lead dioxide) and hydrogen gas from the negative active material (sponge lead). The formation of gas utilises a portion of the available charging current and generates heat. The release of hydrogen and oxygen gas to the atmosphere results in water losses from the battery electrolyte. The evolution of gases also helps to mix the layers of electrolyte and produces a rapid increase in the electrolyte S.G. during the last portion of the charge.

VOLTAGE

As the cell voltage approaches and passes the gassing point there is a sharp increase in cell voltage. At end of charge the charge voltages will level out at approximately 2.7 volts. (Dependant on charging rate and battery age)

TEMPERATURE

Provided that the charge current is not excessive the temperature of the battery remains relatively constant until gassing commences. Up to this point the current is utilised effectively in chemical conversion of the active materials but beyond this it is partially wasted in gassing and causing temperature increases in the cells. As the temperature increases the gassing voltage of the cell decreases. This can result in the charging current increasing which in turn increases temperature. This forms a vicious circle known as thermal runaway which can have a disastrous effect on the battery.

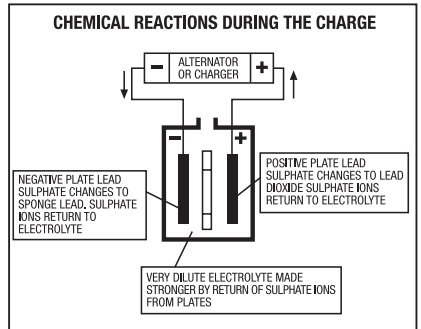

CONSTANT RATE DISCHARGE AND CHARGE GRAPH

Typical Voltage and Gravity Characteristics during a constant rate discharge and recharge.

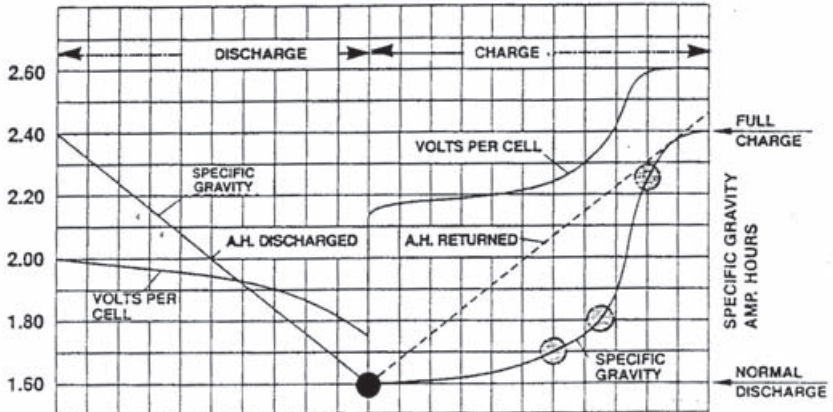

BATTERY CARE AND MAINTENANCE

Modern batteries are designed to give long and trouble free life. The length of this life, however, is dependent on the manner in which the battery is treated in service.

A battery should be kept clean.

A battery should be kept correctly charged.

A battery should have the electrolyte kept at the correct level.

A battery should not be exposed to excessive shocks or vibrations.

CLEANLINESS

A dirty battery tends to hold moisture on the external surface, providing a conductor for electrical current to leak to earth. This discharges the battery and causes the terminal clamp and nearby metalwork to corrode. Therefore it is essential to keep the outside surfaces of a battery free from contamination.

Corrosion will cause a high resistance at connections and although current may flow to run lights etc. it may produce sufficiently high volt drops to prevent engine starting. Corroded connecting surfaces should be cleaned lightly with a fine abrasive and smeared with petroleum jelly or non-oxide grease before re-connecting.

ELECTROLYTE

The term "maintenance free" indicates that under normal operating conditions, the battery should not require topping up during its design life. However the electrolyte level can drop to below the plates if (a) the alternator allows the battery voltage to go to too high a level (b) if the operating temperature is very high or (c) the life of the battery is above that normally expected.

Consequently the level should be checked at least every twelve months and, if it is only just above the plates, topped up to the maximum level with water (This applies for hybrid batteries only). The vent caps of calcium batteries should not be removed.

Only approved water should be used for topping. Tap water may contain harmful contaminants such as chlorides.

Acid should never need to be added to the battery unless there has been spillage. Under normal circumstances only water is lost from the battery. If spillage occurs the battery manufacturer should be consulted for instructions.

Excessive water usage could indicate that the alternators voltage regulator is incorrectly set.

SULPHATION

In the normal operation of a battery the plates are converted to lead sulphate each time it is discharged. The sulphate takes the form of fine crystals which are easily and completely converted on recharging. However, if the plates are allowed to stand in a discharged state for a long period, the "temporary sulphate" may become "permanent sulphate" and become impossible to convert.

The formation of permanent sulphate is accompanied by the growth of large crystals leading to uneven expansion of the plates and eventual buckling.

"Permanent" sulphation is caused by:

- a) Operating a battery in a low state of charge for lengthy periods.
- b) Allowing the battery to stand in a discharged state for a long period.
- c) Leaving a charged battery for long periods without regular recharges.

A possible remedy for a sulphated battery is to charge at 1 amp until the specific gravities have reached maximum and constant levels (whichever is the longer). Rest periods of 8 hours or longer between charging are also helpful. The level of specific gravity at this point will indicate the degree of recovery with a fully recovered battery having specific gravities around 1.270.

Note: The use of additives is not recommended. Despite numerous tests over many years there has

never been any convincing evidence that these concoctions have any merit and some contain elements that are positively harmful to healthy batteries.

INSUFFICIENT CHARGING

Insufficient charging will cause permanent sulphation because the temporary sulphate is not completely removed from the plates during recharge allowing the remainder to convert to permanent sulphate (see Sulphation).

BATTERY LEFT IDLE

A battery left idle in a discharged state for a lengthy period encourages the formation of permanent sulphate and accompanying damage to the plates.

If the battery is to be taken out of service and left idle, the electrolyte must be maintained at the correct level and it should be fully recharged at a low rate every three to four months.

SPECIFIC GRAVITY TOO HIGH

If the specific gravity (15°C) of the electrolyte exceeds 1.300 it will result in increased chemical reaction causing deterioration of the plates and separators and shortening the life of the battery.

OVERCHARGING

Overcharging is charging beyond the time necessary to fully charge the battery or charging at too high a current for the particular battery. It causes corrosion of the positive grids causing them to fracture and reducing their ability to carry the starting current.

Overcharging is usually accompanied by heavy gassing which dislodges active material from the positive plates. This then deposits in the bottom of the container and can lead to short circuiting between the plates.

Overcharging also results in high temperatures which leads to rapid deterioration of the plates and separators.

Buckling of the plates may also occur. This can result in perforation of the separators and internal short circuits.

COMMON CAUSES OF FAILURE

OVERCHARGING

Faulty regulator settings resulting in severe overcharging causes the positive plates to disintegrate and the battery to lose power.

UNDERCHARGING

Faulty regulator settings or a loose fan belt resulting in undercharging causes plates to sulphate and reduces performance. If left unattended for prolonged periods the sulphation becomes almost irreversible and the battery permanently short of capacity.

DEEP DISCHARGE

This is when the battery is discharged to 0% state of charge or even lower (reverse) and is left in this state for a period of time. When these batteries are recharged, excess heat is generated due to the high resistance of the paste (lead sulphate) which can result in damage to the plates and separators.

CYCLING

Any battery can only provide a finite amount of energy (Ah). The number of times a battery is discharged as well as its depth of discharge during each cycle is therefore also finite. When this finite amount of energy has been supplied the battery has exceeded its cycle life. As an automotive battery is mainly for starting, lighting & ignition it should never be cycled this much and this is considered over use.

VIBRATION

Batteries that are not held securely will suffer excessive vibration which can dislodge active material from the grid or break the straps, grids and inter-cell welds.

OVER-TIGHTENING OF CLAMPS

Excessive tightening of hold-down clamps can cause the battery container to crack resulting in leakage of electrolyte. Not only is the battery ruined, but other components are damaged due to corrosion by the acid.

INCORRECT FITMENT OF TERMINALS

Using force when fitting connections to the battery (e.g. hammering on of terminals to the battery positive and negative poles) can damage the internal connections or damage the poles. Always loosen connections properly with the correct size spanners before connecting or disconnecting the terminals.

NEW BATTERY INSTALLATION

PREPARATION OF NEW BATTERY

Check that the specific gravity is 1.250 or higher, or that the open circuit voltage is at least 2.09 volts per cell. If below these levels fully charge the battery before fitting.

REMOVING OLD BATTERY

Before removing the old battery, carefully note the location of the positive battery terminal and mark the polarity on the positive cable. This will minimise the danger of installing the new battery reversed. Remove the "earth" terminal first to avoid damage to wiring or battery by accidentally "earthing" tools.

When removing or tightening nuts use the correct size spanners or wrench.

BATTERY TRAY

After removal of the battery inspect the battery tray for acid damage and ensure that the tray and hold-downs are mechanically strong and free from corrosion. Corroded parts and cable terminals can be cleaned with water (to which household ammonia or baking soda has been added) and scrubbing with a stiff brush. Corroded parts should be dried and painted.

CABLES

Examine the cables to make certain the insulation is intact and that terminal and bolts are not corroded. Replace all unserviceable parts.

INSTALLATION

Make sure there are no foreign objects such as a loose nut or stone lying in the bottom of the tray. These could wear through the battery casing causing loss of acid and failure. The battery should rest level in the tray.

The hold-down should be tightened until it is snug. It should not be tight enough to distort or crack the casing. Use torque values as specified in the car manual if available.

The "earth" cable should be connected to the battery last. Note that reverse polarity connection may cause damage to the electrical system. The positive tapered post is larger than the negative post to minimise the risk of incorrect connections.

Clean cable terminals before connecting them to the battery and apply a thin coating of high temperature non-oxide grease or vaseline to the post and cable terminals to retard corrosion.

Never hammer cable terminals onto battery posts. The lid, internal post connections or post lid insert connections could be severely damaged.

Any time a new battery is fitted the electrical system should be fully checked to ensure starter, alternator

and voltage regulation are operating correctly and that there are no leaks to earth.

TESTING

Battery testing should be included in the periodic service schedule and should be performed even if there have been no starting problems.

VISUAL INSPECTION

Check for container, lid or terminal damage that might cause leakage of electrolyte or internal damage. If serious damage is found the battery must be replaced.

PERFORMANCE TESTS AND WARRANTY ADJUDICATION

SMART TESTER

The “Smart Tester” is a test instrument that enables assessment of the battery to be made simply and quickly whilst providing a written report on the condition of the battery. Generally the “Smart Tester” is able to reach a decision without the battery having to be in a fully charged state. Warranty procedures using the Smart Tester are detailed on page 12 and 13.

STATE OF CHARGE TEST

When using conventional load testers it is essential that the battery is at least 75% charged. The state of charge can be established by measurement of the specific gravity of the electrolyte with a syringe hydrometer.

Draw enough electrolyte into a hydrometer barrel to allow the float to move freely with no pressure on the bulb. Read the specific gravity graduation at electrolyte level on the float. Check every cell in the battery.

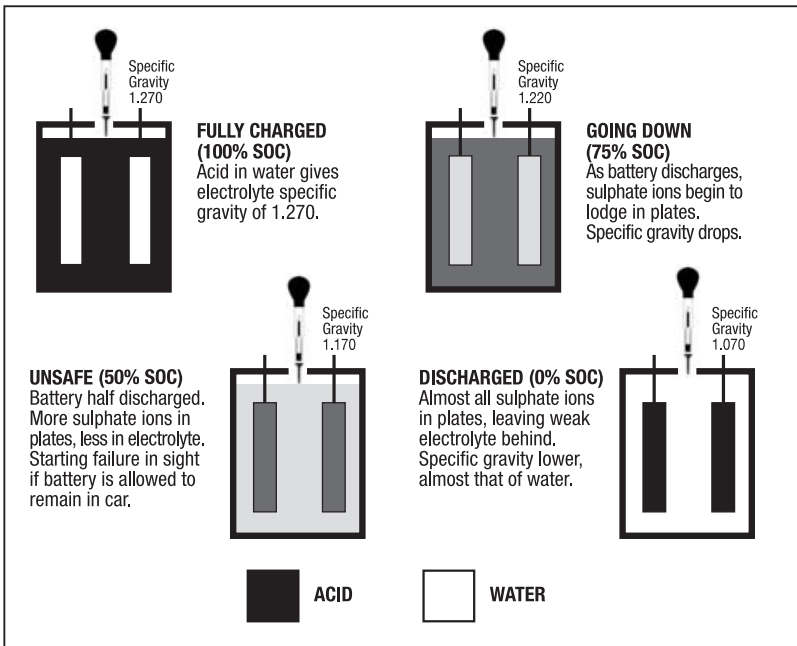

For a new fully charged cell, the specific gravity at 15°C is approximately 1.270 half charged at 1.170 and fully discharged or flat at about 1.070. Below this figure a battery may operate the lights but not start the car.

For a battery of any age, in good condition, all cells should show a similar specific gravity. A variation in specific gravity of up to ten points (0.010) may be accepted, but more than 40 points indicates a faulty cell or cells and the battery should be replaced if high rate testing indicates its inability to carry the load.

Specific gravity varies with the temperature. If the electrolyte temperature is substantially above 15°C add seven points (0.007) to the observed specific gravity reading for every 10°C by which the actual temperature is above 15°C. Deduct seven points per 10°C where the observed reading is below 15°C to obtain the temperature corrected reading at 15°C e.g. observed 1.240 at 25°C true is 1.240 plus .007 = 1.247 at 15°C.

Specific gravity should not be measured immediately after topping up a cell as the added water will float on top of the electrolyte and give a false reading. A charge for thirty minutes or more after topping up will mix the electrolyte and allow accurate readings to be taken. (Ensure the battery is gassing).

NOTE: *If there is insufficient electrolyte in the cells to obtain a hydrometer reading, tilt the battery 30° to one side to increase the electrolyte level over the plates.*

If the level is still too low, top up all cells with battery water and mix by placing on charge at a rate to cause gassing for 15 minutes on a boost charger or 1 hour on a slow charger. Then take specific gravity readings, applying temperature correction if the battery has become hot due to charging, and continue according to the battery testing procedure.

Minimum specific gravity before proceeding to discharge testing should be 1.230.

CHARGING

A battery having specific gravities below 1.230 should be placed on charge at a current equal to between 1% and 2% of the Cold Cranking Current. The battery should only be regarded as being fully charged when the specific gravities have remained constant over three hours. Top of charge specific gravities below 1.230 with minimal variation between the highest and lowest specific gravity are indicative of a permanently sulphated battery. If the electrolyte appears dark in colour when readings are taken it is usually because the battery has been overcharged or has been used in a cycling application (e.g. as a television battery). A difference between the maximum and minimum specific gravity of more than 40 points (0.040) indicates that the battery is faulty and should be replaced.

LOAD TEST

Using an adjustable load resistor the current should be set at the (IEC) Cold Cranking Current for the battery being tested. After discharging for 15 seconds the battery voltage should not drop below 9.0 volts. A battery that falls below this level should be replaced. Warranty procedures using a load resistor are shown on page 14.

CLAIMS ADJUDICATION PROCEDURES

WARRANTY ASSESSMENT USING 'SMART TESTER'

PRELIMINARY ADJUDICATION

REJECT warranty claim batteries under the following circumstances:

OUT OF WARRANTY

ANY BATTERY OLDER THAN 15 MONTHS. This time period begins from the date of fermentation and not sale

SHOWING SIGNS OF ABUSE

- a) damaged container/cover/posts;
- b) contaminated electrolyte/overall low electrolyte levels;
- c) missing vent plugs;
- d) wrong application (e.g. 610 used for leisure application indicated by excessive crocodile clip marks on posts or too small a battery fitted to vehicle).

SECONDARY ADJUDICATION

Connect battery to Smart Tester and select the correct cold cranking rate for the type of battery.

ACCEPT claim should the Smart Tester display **PASS** with the code **3,4 or 19** and the specific gravity readings vary by more than 40 points between cells. **REJECT** if less than 40 points.

ACCEPT claim should the Smart Tester display **REPLACE** with the code **5,6,7,21,28,31,32 or 34**. These codes indicate probable manufacturing faults.

ACCEPT claim should the Smart Tester display the code **20,27 or 36** and the specific gravity readings vary by more than 40 points. **REJECT** if less than 40 points and the battery is merely flat.

REJECT claim should the Smart Tester display **REPLACE** with the code **8,10,12,14,16,18,22,24 or 25** and the average specific gravity is **below 1.250** with a variance of less than 40 points. Reason for rejection is suspected sulphation or overcharge which are common forms of customer abuse. **ACCEPT** claim if specific gravities vary by more than 40 points.

NOTE: F.N.B. from time to time makes small adjustments to its warranty claim procedure. The most up to date procedure can be found in work instruction WI-60-03.

5 POINT TESTING PLAN

(1) INITIAL EXAMINATION

PROOF OF PURCHASE, SOUND APPEARANCE,
APPROVED APPLICATION, WITHIN WARRANTY PERIOD → NO
YES (PERFORM LOAD TEST). WHAT LOAD TEST SHOULD BE PERFORMED? IT DOES NOT
SAY WHAT CURRENT OR TIME? SUGGEST IEC CRANKING CURRENT FOR 15 SECONDS

REJECT



(2) VOLTMETER READINGS

(3) HIGH RATE VOLTS

(4) HYDROMETER READINGS

(5) DECISION

10 to 11.5

Below 9 (Voltage often rises)

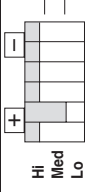

ACCEPT
(manufacturing defect)



10 to 11.5

Below 9 (Voltage often rises)

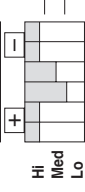

ACCEPT
(manufacturing defect)



0 to 12.6

Below 3 (Voltage normally zero)

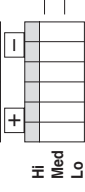

ACCEPT
(manufacturing defect)



6 - 12.4

Below 9 (Voltage steadily falls)

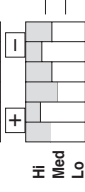

REJECT
service abuse



Below 10

Below 3 (Voltage can be zero)

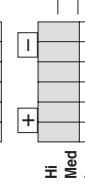

REJECT
(over-discharge unlikely to recover)



Above 11.5

3 to 9 (Voltage remains stable)

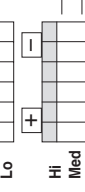

REJECT
(service abuse)



OPEN CIRCUIT VOLTAGE - Record open circuit voltage (OCV) readings.

HIGH RATE DISCHARGE - Record High Rate Discharge (HRD) readings and note the movement of the needle.

HYDROMETER - Record readings from each cell. The cell nearest the positive terminal is identified as Cell No. 1. Using the Hydrometer as a pump on the two end cells, check for discoloured electrolyte.

DECISION - Identify the result of the checks WITH the diagnostic chart steps (2) to (4). The nearest combinations will indicate the correct decision, after taking into account "Additional Information".

ADDITIONAL INFORMATION:

- (a) Batteries may be undercharged or overcharged as a result of a malfunction of the vehicle's electrical system. This is not a faulty battery and the vehicle electricians should be checked.
- (b) If the open circuit voltage check shows a reading below 10.0 Volts, it may not be capable of being successfully recharged and its further service life is often substantially reduced.
- (c) Where discoloured electrolyte is observed, it is always due to service-related conditions.
- (d) Gassing cells in a discharged battery, or where discoloured electrolyte is observed is most unlikely to be a manufacturer's fault.

STORAGE, CHARGING & FITTING

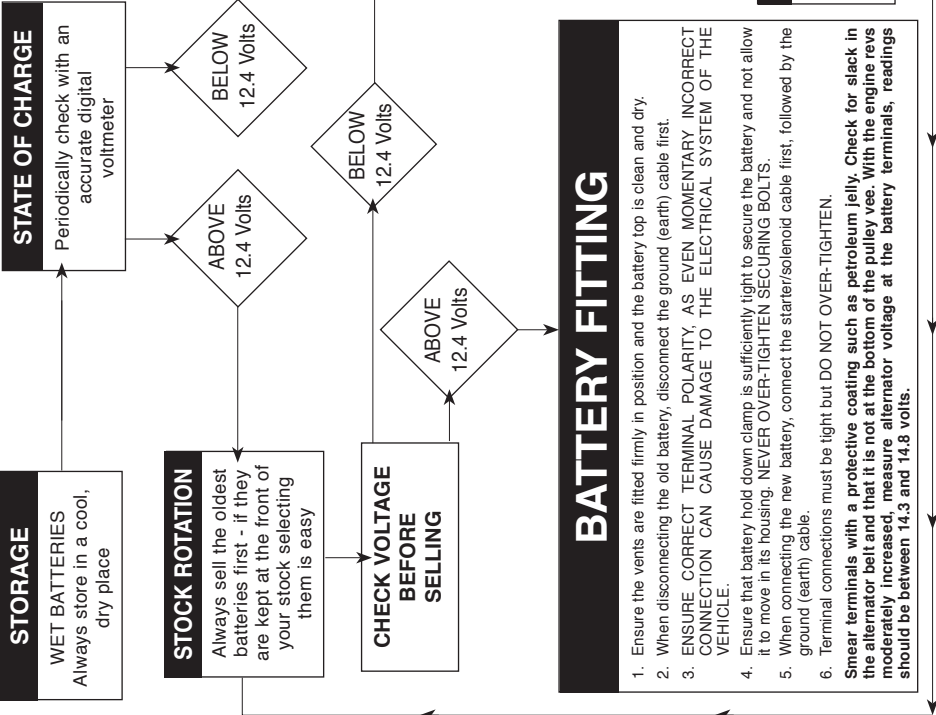

STORAGE
WET BATTERIES
Always store in a cool,
dry place

STATE OF CHARGE
Periodically check with an
accurate digital
voltmeter

STOCK ROTATION
Always sell the oldest
batteries first - if they
are kept at the front of
your stock selecting
them is easy

**CHECK VOLTAGE
BEFORE
SELLING**

BATTERY FITTING

1. Ensure the vents are fitted firmly in position and the battery top is clean and dry.
2. When disconnecting the old battery, disconnect the ground (earth) cable first.
3. ENSURE CORRECT TERMINAL POLARITY, AS EVEN MOMENTARY INCORRECT CONNECTION CAN CAUSE DAMAGE TO THE ELECTRICAL SYSTEM OF THE VEHICLE.
4. Ensure that battery hold down clamp is sufficiently tight to secure the battery and not allow it to move in its housing. NEVER OVER-TIGHTEN SECURING BOLTS.
5. When connecting the new battery, connect the starter/solenoid cable first, followed by the ground (earth) cable.
6. Terminal connections must be tight but DO NOT OVER-TIGHTEN.

Smear terminals with a protective coating such as petroleum jelly. Check for slack in the alternator belt and that it is not at the bottom of the pulley vee. With the engine revs moderately increased, measure alternator voltage at the battery terminals, readings should be between 14.3 and 14.8 volts.

CHARGING
Remove any wrappings and charge without delay to prevent permanent damage.
Using a variable charger - set rate between 3 and 4 amps for batteries up to 90 Ampere Hrs and 5 to 7 amps for those above.
Charge for 12 hours.

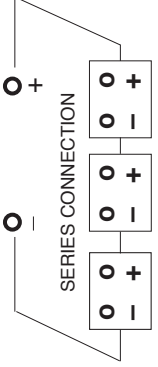

Series Charging - only with units of similar capacities.

CHARGE ASSESSMENT
Stand 8 hours after completion of charge then measure battery voltage.
ALTERNATIVELY, should immediate use be required measure all cells with a Hydrometer.

Above
12.6 Volts
OR MIN
1.260SG

YES

NO

DATE CODING
Date coding each
battery with date on
which it was last
charged.

BACK TO “BATTERY BASICS”

THE POWER TEAM

Not every starting problem comes from the battery!

When you experience a starting problem be aware that the battery is only a part of the “team” in the electrical circuit of your motor car. The battery’s function is to capture and store the electrical energy produced by the alternator and make this available to the starter motor, and to provide the power for all the other electrical components. If any of them are problematic then the battery will not be able to fulfill it’s function.

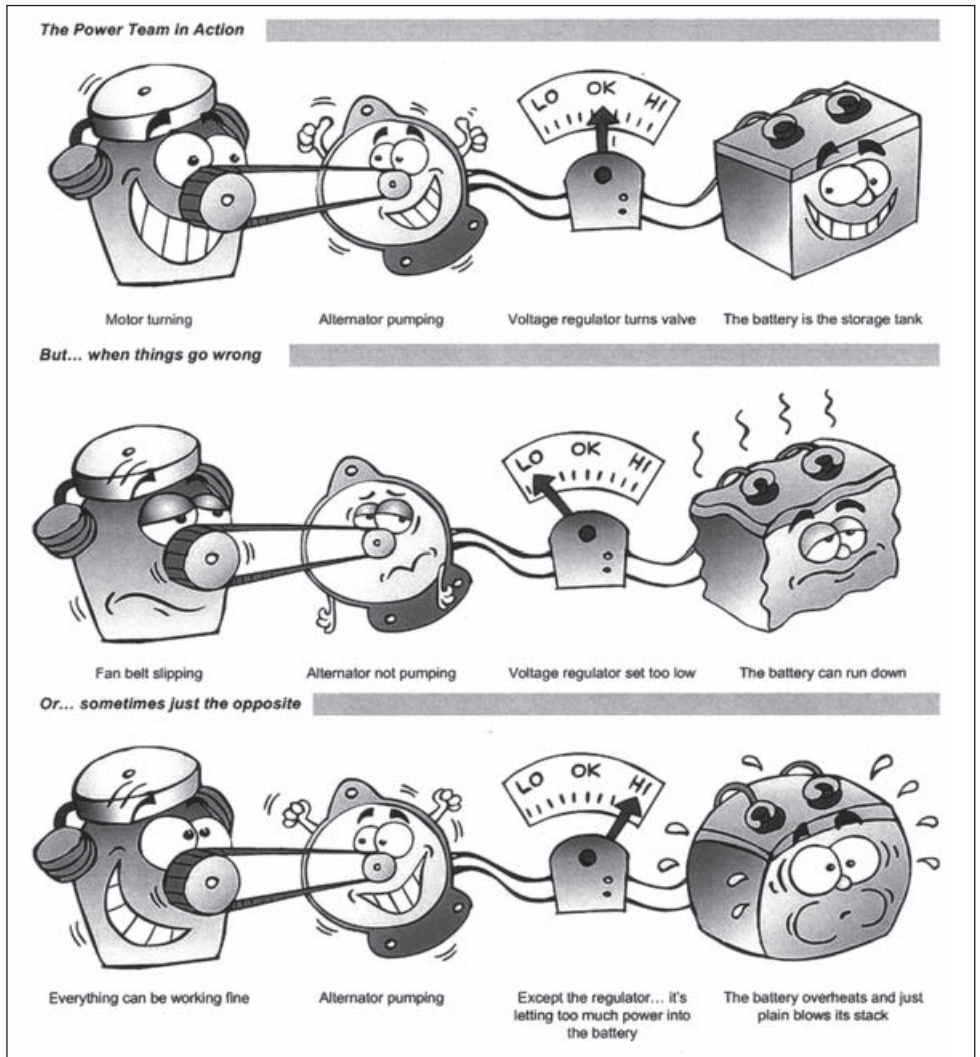

BATTERY ACID / SULPHURIC ACID <51%



HAZARDS

- Corrosive - Will cause serious burns to skin, eyes and clothing. Inhalation of fumes will damage mucous membranes and lungs. Ingestion will severely burn.
- Fire & Explosion - Contact with most metal will cause release of flammable and explosive hydrogen gas. Fire will produce irritating and toxic fumes.
- Environment - Spillages not properly contained will cause environmental pollution.

SAFETY PRECAUTIONS

- Wear protective clothing, - face, foot, hand protection and PVC apron.
- When mixing add acid to water.
- Handle containers carefully to avoid spillage.

STORAGE AND HANDLING

- Store in a containment area.
- Store containers upright with caps securely fastened.
- Do not stack containers.
- Store in a cool dry place.
- Do not store incompatible chemicals together.
- Provide spill kit to treat spillages.

EMERGENCY

Remove personnel from area.

IN CASE OF	DO THIS
FIRE	<ol style="list-style-type: none">1. Wear correct protective clothing.2. Isolate area.3. Use CO₂ or water spray.4. Move containers if safe.5. Do not use jets of water.6. Do not allow fire water or acid to enter drain systems.
SPILLAGE	<ol style="list-style-type: none">1. Eliminate any source of ignition.2. Wear correct protective clothing.3. Dam acid and prevent entry into drains, waterway & sewers.4. Stop leakage.5. Clean up using absorbent material.6. Dispose of spill material as hazardous material.
EXPOSURE	<ol style="list-style-type: none">1. Always seek medical attention.2. Eyes - Rinse with cool running water for at least 15 minutes.3. Skin - Wash thoroughly with cool running water for at least 15 minutes.4. Ingestion - Do not induce vomiting, give plenty to drink - only if victim is conscious.5. Inhalation - Remove to fresh air. If victim is not breathing give artificial respiration. <p>CALL FOR OR GET MEDICAL ATTENTION IN ALL CASES.</p>

LEISURE BATTERY RANGE



Caravans



Television
Audio
Appliance



Mobile Homes



Solar



Boating

Battery Type	Length	Width	Height	Terminal	Wet weight (kg)	Capacity 20Hr Rate
RR0	247	174	214	Standard Taper	14.2	40
RR1	247	174	214	Standard Taper	15.6	50
RR2	346	174	226	Standard Taper	26.9	96
SMF100/101	328	171	241	Standard Taper	25.4	102

The First National Battery Range has the ability to withstand frequent and deep charge and discharge cycles which ensures that the batteries last longer than conventional automotive batteries used under the same conditions.

HOW TO CALCULATE THE TYPE OF BATTERY YOU NEED:

Applications	Power P	Voltage V	Current I = P/V	Hours of use	Capacity Ah
Caravans 1 x 40W Bulb	40W	12V	3.3A	4h	13.2 Ah
Portable TV	50W	12V	4.2A	4h	16.8 Ah
If used together: Capacity required = $13.2 + 16.8 \times 1.25^* = 37.5$ Ah. A: RR0 has capacity (4–8h) ⁺ of approx. $0.85 \times 40\text{Ah} = 34\text{Ah}$. B: RR1 has capacity (4–8h) ⁺ of approx. $0.85 \times 50\text{Ah} = 42.5\text{Ah}$. Therefore use RR1 battery					
Lighting 2 x 40W Bulbs	80W	12V	6.7A	6h	40.2 Ah
Capacity required = $40.2 \times 1.25^* = 50.3\text{Ah}$. C: RR2 has capacity (4–8h) ⁺ of approx. $0.85 \times 96\text{Ah} = 81.6\text{Ah}$. Therefore use RR2 battery					
Portable television	50W	12V	4.2A	4h	16.8 Ah
Capacity required = $16.8 \times 1.25^* = 21$. As in A above RR0 has capacity (4–8h) ⁺ rate of approx. 34Ah. Therefore use RR0 battery					
Boating Refrigerator	60W	12V	5A	8h	40 Ah
VHF Radio	1W	12V	0.08A	5h	0.4 Ah
GPS Navigation System	8W	12V	0.7A	3h**	2.1 Ah
Auto Pilot	24W	12V	2.0A	5h	10.0 Ah
TOTAL					52.5 Ah
If used together: Capacity required = $52.5 \times 1.25^* = 62.62\text{Ah}$. In C above RR2 has capacity (4–8h) ⁺ rate of approx. 81.6Ah. Therefore use RR2 battery					

* The security factor is used to protect against over discharge. These batteries should never be discharged to greater than 80% of their capacity.

+ The capacity of a battery decreases as you increase the discharge rate. 40Ah for an RR2 only refers to a 20h discharge ie: 2A for 20h. In this example I have used the approximate 5h capacity of the RR range as a better estimate of 4–8h battery capacity.

** 3h capacity would be lower than 85% of 20h capacity

RECHARGING THE LEISURE BATTERY

The batteries are charged at a current equivalent to 0.1 times the capacity expressed in Ampere hours (Ah) for a maximum duration of 15 hours. The duration of the recharge will depend on the extent of the discharge that the battery has experienced. As an example the 50 Ah type RR1 battery that has been utilised for 3 hours for lighting a 100W lamp would have consumed 25 Ah and therefore must be charged at 5 Ampere for approximately 6.2 hours.

TWIN BATTERY SETUPS

The practice of fitting an auxiliary battery in a motor vehicle for recreational purposes, is becoming common. It is accordingly of benefit to understand the physical principles involved in using such a battery.

Stated broadly, the objective is to have a second battery (the auxiliary) which will provide energy for the operation of additional electrical loads like fridges and TV sets when the engine is switched off. This auxiliary battery is connected in parallel with the starter battery in order to maintain the system voltage, usually 12V. It has to be used in a manner that will not jeopardize the working of the starter battery. Even with the mass arrival of cell phones, and rapid response teams, failure to start a vehicle in a remote area is definitely an event to be avoided.

A number of methods have been devised for managing this arrangement, and these should be approached with a basic understanding of how alternators behave toward batteries in parallel (connected positive to positive and negative to negative), and how batteries in parallel behave toward each other.

The main rules of the game are as below:

- Batteries in differing states-of-charge, and therefore with differing open-circuit voltages, will rapidly attain the same voltage when connected in parallel; this remains true even when the batteries are charging or discharging. This is so because voltage is the driving force in this situation, and a 40 Ah battery will discharge happily into a 100Ah battery with a lower voltage, until their voltages are equal. Expressed in another way, current will flow as long as a voltage difference exists.
- The rate in amps at which the alternator will charge a battery is determined by three factors, viz, the difference between alternator and battery voltage, the internal resistance of the battery, and the temperature of the battery.
- When charging two batteries in parallel, the alternator will be faced with two batteries having the same voltage. Internal resistance now becomes the main factor and the charging current will thus be divided between the two batteries roughly in the ratio of their respective Ah capacities, the larger current being taken by the bigger battery. This happens simply because the bigger battery has a lower internal resistance than a smaller battery of similar design.

The implications of the above rules are twofold:

- A discharged auxiliary battery will draw current from the starter battery if inadvertently connected to it. Should the auxiliary battery have been deeply discharged, the voltage of the starter battery may be depressed to a level where it will not start the vehicle (less than 12.0V) and this fact must be taken into account when installing a second battery.
- The auxiliary battery is invariably bigger than the starter battery and will have a lower internal resistance. It will therefore receive preferential treatment from the alternator. This is convenient since

the starter battery is usually less in need of a charge than the auxiliary battery.

Parallel configuration are in worldwide use, even in installations such as nuclear power stations, and have given excellent service. The only special requirement is that no unnecessary resistance be introduced into the circuit in the form of thin cables or poor electrical connections. As far as the alternator is concerned, the unit fitted to the car will in most instances cope with the two batteries. Even calcium batteries being charged by present-day alternators at 14.4V are being maintained in a satisfactory state-of-charge. Nevertheless, First National Battery recommend an annual charge at a Battery Centre or other auto-electrical workshop at which the driver must insist on the use of a constant-current charger which has no voltage limitations.

When battery-powered winches are to be used, batteries of the recreational type are ideal, as this is an arduous application which cycles the battery to some extent. This battery type serves well as an auxiliary battery because it withstands cycling while at the same time providing the high current for winches.

Management of the parallel arrangement by a simple system, using one or two automotive relays, has been found to work well. This isolates the starter battery when the ignition is switched off. We have not investigated the other methods available and can therefore not offer any comments.

The contribution to this article by CAR magazine is gratefully acknowledged.

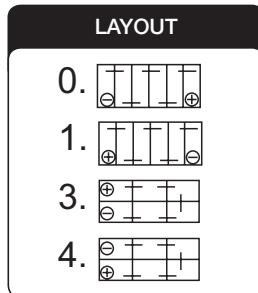
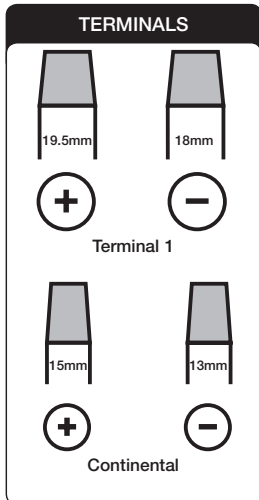
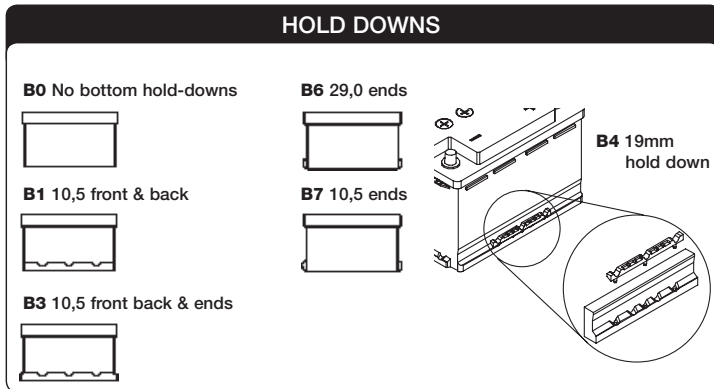

JUMP STARTING PROCEDURE

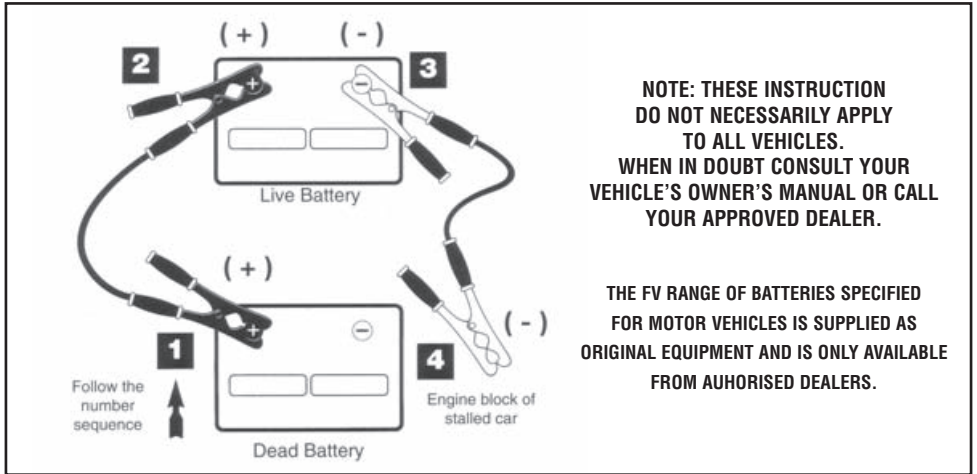

If jumper cables are available and the booster battery is in another car; in both cars, set handbrakes, turn off all switches, place gear selector in Neutral or Park position, make certain cars do not touch, then proceed in this exact sequence –

- 1 Connect the red cable clamp to the positive post of the discharged battery.
- 2 Connect other end of the red cable clamp to the positive post of the live battery.
- 3 Connect the black cable clamp to the negative post of the live battery.
- 4 MAKE FINAL CONNECTION ON ENGINE BLOCK OF STALLED CAR - as far away as possible from battery. Make certain cars do not touch.
- 5 Attempt to start 'dead vehicle' with 'live vehicle' engine OFF. If vehicle has not started in 15 seconds stop procedure and check ignition and fuel systems.
6. To remove cables - reverse this exact procedure.

WARRANTY & CLAIMS DOCUMENTATION PROCEDURE

1. Separate WCF for each accepted warranty claim forwarded to the factory.
2. WCF number to appear on lid of battery with waterproof white marker
3. Where applicable Smart Test Code to appear on WCF plus specific gravities if this is the reason for acceptance.
4. Where applicable Smart Test Report to be attached to WCF.
5. Summarise and attach all relevant claims on RFC
6. Return claim batteries and relevant documentation together to First National Battery.
7. **O.E. Claims**

Procedure as above but include copy of Service Book and must be clearly marked "O.E." on WCF.

STARTER BATTERY WARRANTY

Metindustrial (Pty) Limited - trading through its division First National Battery ("FNB") warrants to the original purchaser only, for a period of twelve (12) months as from date of purchase, that this battery is free of defects in material and workmanship under normal use and service conditions and in terms of correct application.

This warranty extends to the Republic of South Africa, Botswana, Lesotho, Malawi, Mozambique, Namibia and Swaziland only.

In the event of any defects in material and/or workmanship arising within the said twelve (12) month period, FNB undertakes, in its sole discretion to repair the defect or replace the battery at its own cost and without charge to the purchaser, subject to the following conditions:-

1. Any claim in terms of this warranty must be made as soon as the purchaser becomes aware of the defect and which must become apparent within the twelve (12) month warranty term;
2. The purchaser must return the defective battery to FNB or its duly authorised agents and exhibit satisfactory proof of purchase of the battery from FNB or its duly authorised agents;
3. The warranty on the repaired or replaced battery shall extend from the original date of purchase of the "defective" battery;
4. This warranty shall not apply where the battery is used in a vehicle whose specifications requires a battery of a different size / ampere hour capacity or where this battery is fitted below or above the suggested ampere hour capacity (at the 20 hour rate) as specified in FNB'S official Battery Selection Guide or, in the case of original equipment installed by a vehicle manufacturer, not according to their official specified capacity;
5. This warranty is void if failure of the battery has resulted from abuse or neglect; improper use / mis-application (including incorrect over or under charging; failure to keep the battery properly charged or maintained; or use in automotive vehicles without properly operating starting or charging systems); use of the battery in continuous shift; overheating; overfilling; tipping over; missing or loose vent caps; use of battery acid or additives; excessive use and abnormal wear and tear during the warranty term (including commercial use); use in a vehicle fitted with additional or non-standard electrical extras; environmental conditions or any other damage arising from, inter alia, accident / collision, fire, explosion, freezing, theft, civil commotion, labour / political unrest or rioting;
6. This warranty shall, further, not apply where the battery is otherwise used in applications for which this battery was not designed;
7. This warranty is in lieu of any warranties (express or implied) or conditions implied by law, which are hereby specifically excluded;
8. FNB and its duly authorised agents exclude all liability for damage, loss or injury howsoever suffered and shall not be held liable for any damages, losses, injury, expenses or costs (whether of a direct, indirect, consequential, incidental or other nature) howsoever suffered and by whomsoever suffered which may arise out of or relate to the use or inability to use this battery or any failure whatsoever to meet this warranty.

LEISURE BATTERY WARRANTY

Metindustrial (Pty) Limited - trading through its division First National Battery ("FNB") warrants to the original purchaser only, for a period of twelve (12) months as from date of purchase, that this battery is free of defects in material and workmanship under normal use and service and in terms of correct application.

This warranty extends to the Republic of South Africa, Botswana, Lesotho, Malawi, Mozambique, Namibia and Swaziland only.

In the event of any defects in material and/or workmanship arising within the said twelve (12) month period, FNB undertakes, in its sole discretion, to repair the defect or replace the battery at its own cost and without charge to the purchaser subject to the following conditions:-

1. Any claim in terms of this warranty must be made as soon as the purchaser becomes aware of the defect and which must become apparent within the twelve (12) month warranty term;
2. The purchaser must return the defective battery to FNB or its duly authorised agents and exhibit satisfactory proof of purchase of the battery from FNB or its duly authorised agents;
3. The warranty on the repaired or replaced battery will extend from the original date of purchase of the "defective" battery;
4. This warranty shall not apply where the battery is used as a vehicle starter battery or in applications of deep cycle use such as in scrubbers, sweepers or golfcarts;
5. This warranty is void if failure of the battery has resulted from failure to maintain the battery in a fixed position, abuse or neglect; improper use / mis-application (including applications not provided for); incorrect over or under charging (whether due to a faulty electrical system or charging apparatus or failure to keep the battery properly charged or maintained); use of battery acid or additives; excessive / abnormal wear and tear; overheating; overfilling; environmental conditions or any other damage whatsoever arising from, inter alia, accident / collision / tipping of the craft wherein the battery is housed; fire, explosion, freezing, theft, civil commotion, labour / political unrest or rioting;
6. This warranty is in lieu of any warranties (express or implied) or conditions implied by law, which are hereby specifically excluded;
7. FNB and its duly authorised agents exclude all liability for damage, loss or injury howsoever suffered (including but not limited to damage or loss suffered as a result of leaked battery acid) and shall not be held liable for any damages, losses, injury, expenses or costs (whether of a direct, indirect, consequential, incidental or other nature) howsoever suffered and by whomsoever suffered which may arise out of or relate to the use or inability to use this battery or any failure to meet this warranty.

SMF100/101 STARTER BATTERY WARRANTY

Metindustrial (Pty) Limited - trading through its division First National Battery ("FNB") warrants to the original purchaser only, that this battery will be free of defects in material and /or workmanship, under normal use and service conditions and in terms of correct application, for a period of twelve (12) months as from date of purchase ("warranty term").

This warranty extends to the Republic of South Africa, Botswana, Lesotho, Malawi, Mozambique, Namibia and Swaziland only.

FNB's sole obligation in terms of this warranty shall be, in the event of any defects in material and/or workmanship arising within the warranty term to, in its sole discretion, repair or replace the battery, without charge to the purchaser, within a reasonable time period, subject to the following conditions:-

1. Any claim in terms of this warranty must be made as soon as the purchaser becomes aware of the defect and which must become apparent within the warranty term: Failure to notify FNB or its duly authorised agents of any alleged defect, within the warranty term, will render the warranty void;
2. The purchaser must return the defective battery to FNB or its duly authorised agents free of charge within the warranty term and exhibit satisfactory proof of purchase of the battery from FNB or its duly authorised agents;
3. The warranty on the repaired or replaced battery shall extend from the original date of purchase of the "defective" battery;
4. This warranty shall not apply where the battery is used in a vehicle whose specifications requires a battery of a different size / ampere hour capacity or where this battery is fitted below or above the suggested ampere hour capacity (at the 20 hour rate) as specified in FNB'S official Battery Selection Guide or, in the case of original equipment installed by a vehicle manufacturer, not according to their official specified capacity;
5. This warranty is void if failure of the battery has resulted from abuse or neglect; improper use / mis-application (including incorrect over or under charging and excessive cycling; failure to keep the battery properly charged or maintained; or use in automotive vehicles without properly operating starting or charging systems); use of the battery in continuous shift; overheating; tipping over; excessive use and abnormal wear and tear during the warranty term (including commercial use): use in a vehicle fitted with additional or non-standard electrical extras; environmental conditions or any other damage arising from, inter alia, accident / collision, fire, explosion, freezing, theft, civil commotion, labour / political unrest or rioting;
6. This warranty shall, further, not apply where the battery is otherwise used in applications for which this battery was not designed including solar applications and as a back-up power source;
7. This warranty is in lieu of any warranties (express or implied) or conditions implied by law, which are hereby specifically excluded and no warranties, representations or undertakings of whatever nature have been made or given by FNB or on its behalf other than as stated herein;
8. FNB and its duly authorised agents exclude ail liability for damage, loss or injury howsoever suffered and shall not be held liable for any damages, losses, injury, expenses or costs (whether of a direct, indirect, consequential, incidental or other nature) howsoever suffered and by whomsoever suffered which may arise out of or relate to the use or inability to use this battery or any failure whatsoever to meet this warranty.

MOTORCYCLE BATTERY WARRANTY

Metindustrial (Pty) Limited – trading through its division First National Battery (“FNB”) warrants to the original purchaser only, for a period of three (3) months as from date of purchase, that this battery is free of defects in material and workmanship under normal use and service and in terms of correct application.

This warranty extends to the Republic of South Africa, Botswana, Lesotho, Malawi, Mozambique, Namibia and Swaziland only.

In the event of any defects in material and / or workmanship arising within the said three (3) month period, FNB undertakes, in its sole discretion, to repair the defect or replace the battery at its own cost and without charge to the purchaser subject to the following conditions:

1. Any claim in terms of this warranty must be made as soon as the purchaser becomes aware of the defect and which must become apparent within the three (3) month warranty term;
2. The purchaser must return the defective battery to FNB or its duly authorised agents and exhibit satisfactory proof of purchase of the battery from FNB or its duly authorised agents;
3. The warranty on the repaired or replaced battery will extend from the original date of purchase of the “defective” battery;
4. This warranty shall only apply to where the battery is used as a starter battery for a motorcycle and shall not apply where the battery is used in other applications such as in off-road quad bikes jet skis and the like.
5. This warranty is void if failure of the battery has resulted from failure to maintain the battery in a fixed position, abuse or neglect; improper use / mis-application (including applications not provided for); incorrect over or under charging (whether due to a faulty electrical system or charging apparatus or failure to keep the battery properly charged or maintained); use of battery acid or additives; excessive / abnormal wear and tear; overheating overfilling; environmental conditions or any other damage whatsoever arising from accident / collision / inverting of the battery ; fire, explosion, freezing, theft, civil commotion, labour / political unrest or rioting.
6. This warranty is in lieu of any warranties (express or implied) or conditions implied by law, which are hereby specifically excluded;
7. FNB and its duly authorised agents exclude all liability for damage, loss or injury howsoever suffered (including but not limited to damage or loss suffered as a result or leaked battery acid) and shall not be held liable for any damages, losses, injury, expenses or costs (whether of a direct, indirect, consequential, incidental or other nature) howsoever suffered and by whomsoever suffered which may arise out of or relate to the use or inability to use this battery or any failure to meet this warranty.



THROUGH CARING WE LEAD™

FIRST NATIONAL BATTERY COMPANY (PTY) LTD.

REG.66/05564/07

BENONI

LIVERPOOL & BRISTOL ROADS, BENONI SOUTH
PO BOX 5015, BENONI SOUTH 1502, SOUTH AFRICA
PHONE +27 11 741-3600
FAX +27 11 421-2642/421-1625
email: marketing@battery.co.za

EAST LONDON

SETTLERS WAY & EDISON ROAD
GATELY TOWNSHIP, EAST LONDON
PO BOX 182, EAST LONDON 5200, SOUTH AFRICA
PHONE +27 43 706 8200
email: manufacture@battery.co.za

www.battery.co.za